

## Excellent Integrated System Limited

Stocking Distributor

Click to view price, real time Inventory, Delivery & Lifecycle Information:

[Semtech](#)  
[RCLAMP7528T.TNT](#)

For any questions, you can email us directly:

[sales@integrated-circuit.com](mailto:sales@integrated-circuit.com)



## RClamp7528T Ultra Low Capacitance TVS Array

### PROTECTION PRODUCTS - RailClamp®

#### Description

RailClamp® TVS arrays are ultra low capacitance ESD protection devices designed to protect high speed data interfaces. This series has been specifically designed to protect sensitive components which are connected to high-speed data and transmission lines from overvoltage caused by **ESD** (electrostatic discharge), **CDE** (Cable Discharge Events), and **EFT** (electrical fast transients).

The RClamp®7528T has a typical capacitance of only 0.25pF between I/O pins. This allows it to be used on circuits operating in excess of 3GHz without signal attenuation.

The RClamp7528T is in a 9-pin SLP2611N9T package. It measures 2.6 x 1.1mm with a nominal height of 0.40mm. The innovative flow through package design simplifies pcb layout and maximizes signal integrity on high-speed lines. Each device will protect eight lines and requires less board space than existing solutions.

The combination of small size, low capacitance, and high level of ESD protection makes this device a flexible solution for applications such as HDMI, MHL, MDDI, and eSATA interfaces.

#### Features

- ◆ ESD protection for high-speed data lines to **IEC 61000-4-2 (ESD) ±25kV (air), ±20kV (contact)**  
**IEC 61000-4-5 (Lightning) 5A (8/20µs)**  
**IEC 61000-4-4 (EFT) 40A (5/50ns)**
- ◆ Package design optimized for high speed lines
- ◆ Flow-Through design
- ◆ Protects eight high-speed lines
- ◆ Low capacitance: **0.25pF** typical (I/O to I/O)
- ◆ Low ESD clamping voltage
- ◆ Extremely low dynamic resistance: 0.30 Ohms (Typ)
- ◆ Solid-state silicon-avalanche technology

#### Mechanical Characteristics

- ◆ SLP2611N9T 9-pin package (2.6 x 1.1 x 0.40mm)
- ◆ Pb-Free, Halogen Free, RoHS/WEEE Compliant
- ◆ Lead Pitch: 0.50mm
- ◆ Lead finish: NiPdAu
- ◆ Marking: Marking Code
- ◆ Packaging: Tape and Reel

#### Applications

- ◆ HDMI 1.4
- ◆ USB 3.0
- ◆ MHL
- ◆ LVDS Interfaces
- ◆ PCI Express
- ◆ eSATA Interfaces

#### Dimensions

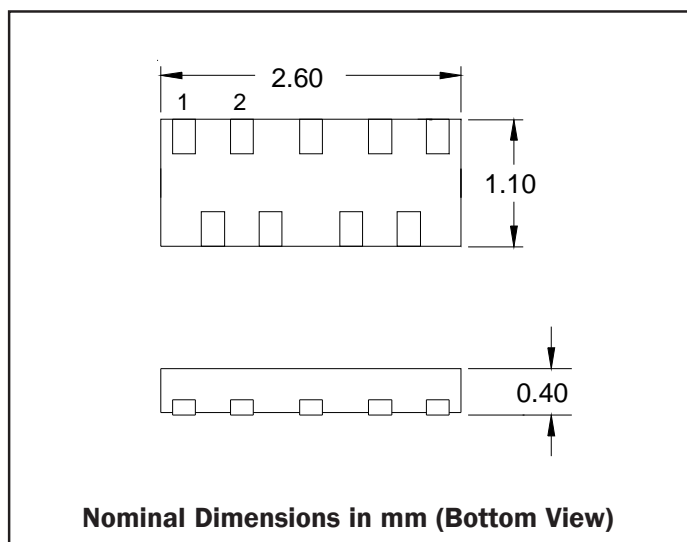

#### Circuit Diagram

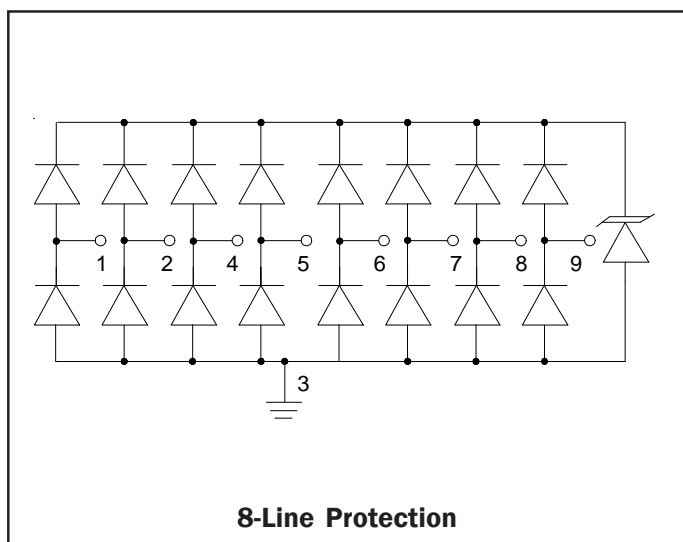



# RClamp7528T

## PROTECTION PRODUCTS

### Absolute Maximum Rating

Rating	Symbol	Value	Units
Peak Pulse Power (tp = 8/20μs)	$P_{pk}$	75	Watts
Peak Pulse Current (tp = 8/20μs)	$I_{pp}$	5	A
ESD per IEC 61000-4-2 (Air) ESD per IEC 61000-4-2 (Contact)	$V_{ESD}$	+/- 25 +/- 20	kV
Operating Temperature	$T_J$	-55 to +125	°C
Storage Temperature	$T_{STG}$	-55 to +150	°C

### Electrical Characteristics (T=25°C)

Parameter	Symbol	Conditions	Minimum	Typical	Maximum	Units
Reverse Stand-Off Voltage	$V_{RWM}$	Any I/O to GND			5	V
Reverse Breakdown Voltage	$V_{BR}$	$I_t = 1mA$ , Any I/O to GND	6.5	9	11	V
Reverse Leakage Current	$I_R$	$V_{RWM} = 5.0V$ , Any I/O to GND		0.005	0.100	μA
Clamping Voltage	$V_C$	$I_{pp} = 1A$ , tp = 8/20μs Any I/O to GND			12	V
Clamping Voltage	$V_C$	$I_{pp} = 5A$ , tp = 8/20μs Any I/O to GND			15	V
Junction Capacitance	$C_j$	$V_R = 0V$ , f = 1MHz, Any I/O to GND		0.50	0.60	pF
		$V_R = 0V$ , f = 1MHz, Between I/O pins		0.25	0.4	pF

**PROTECTION PRODUCTS**

**Typical Characteristics**

**Non-Repetitive Peak Pulse Power vs. Pulse Time**

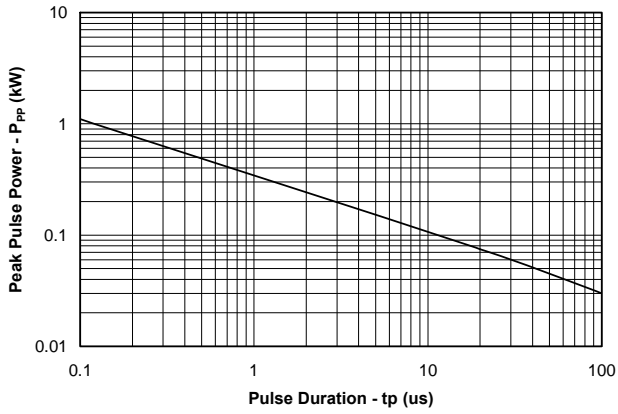

**Pulse Waveform**

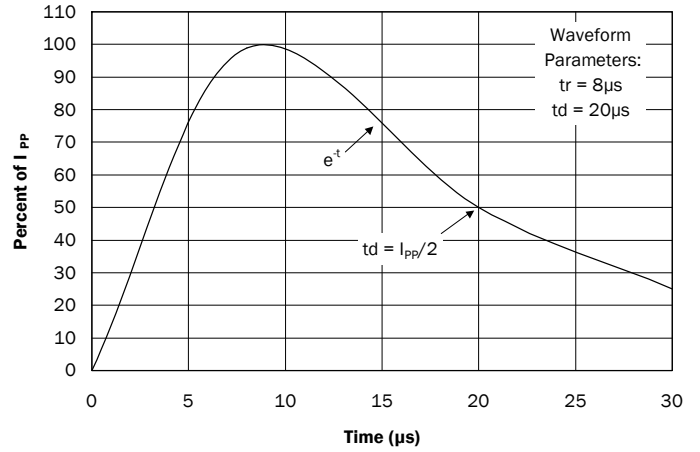

**Clamping Voltage vs. Peak Pulse Current  
(Between any I/O and Ground)**

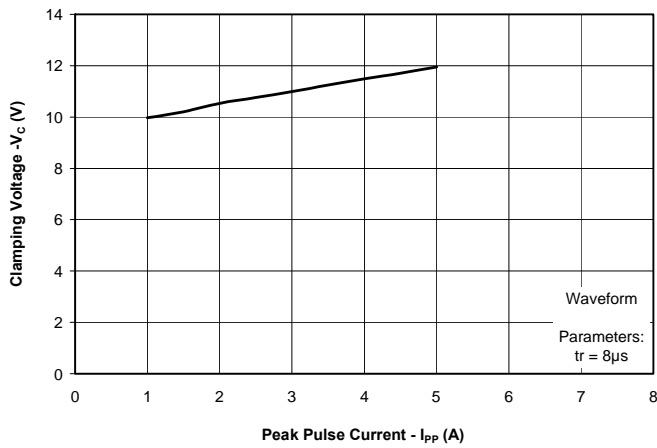

**Normalized Capacitance vs. Reverse Voltage**

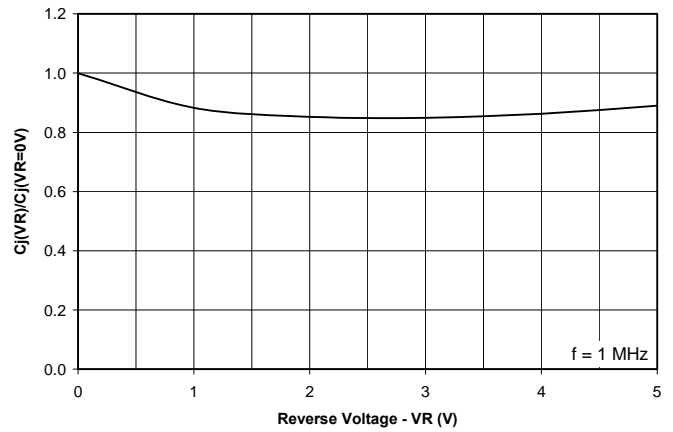

PROTECTION PRODUCTS

Typical Characteristics (Con't)

Insertion Loss S21 - I/O to GND

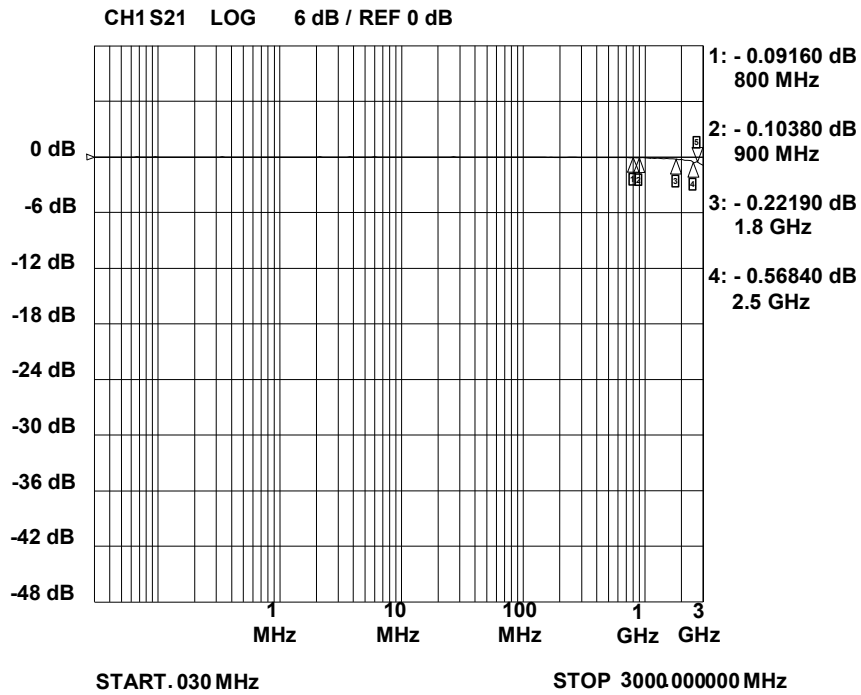

Insertion Loss S21 - I/O to I/O

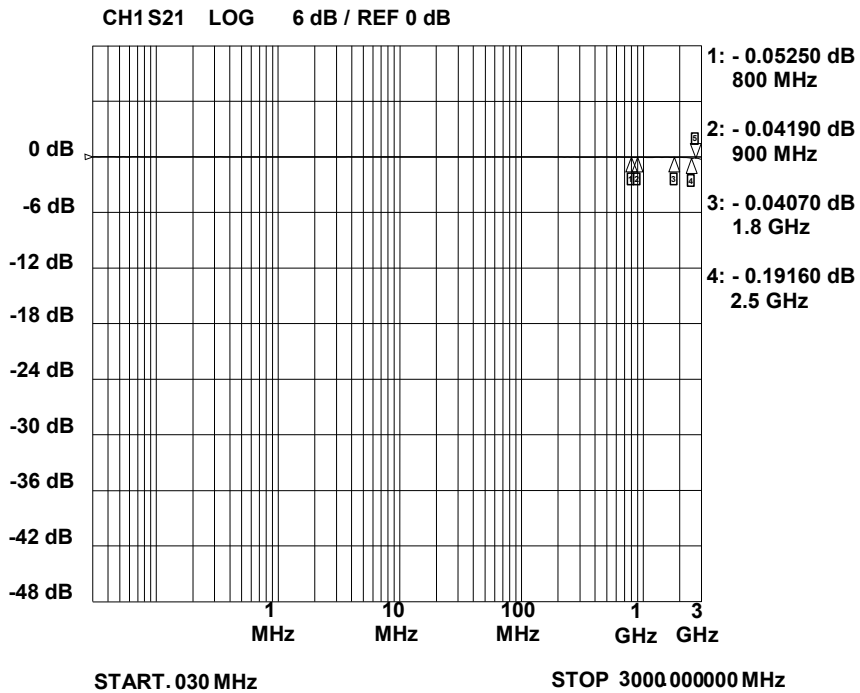

**PROTECTION PRODUCTS**

**Typical Characteristics (Con't)**

**HDMI 1.4 Eye Pattern with RClamp7528T**

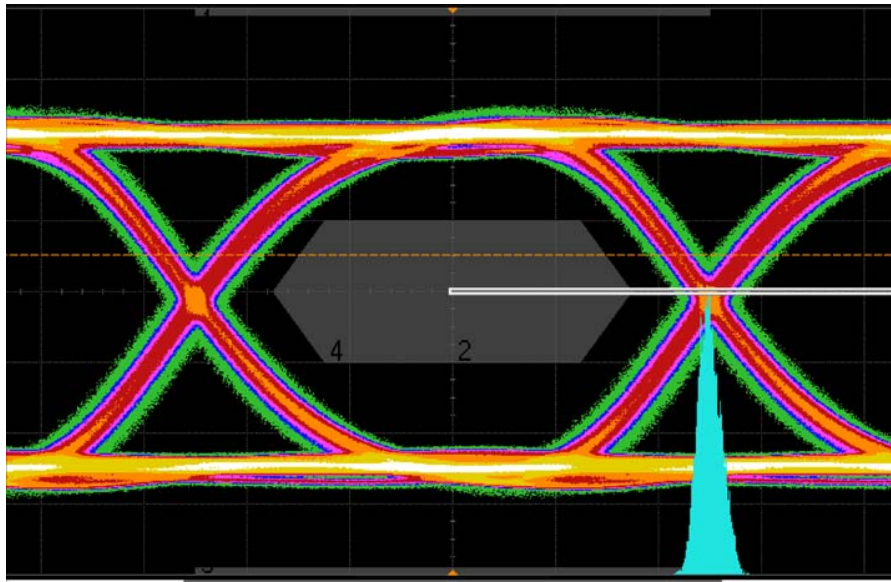

**USB 3.0 Eye Pattern with RClamp7528T**

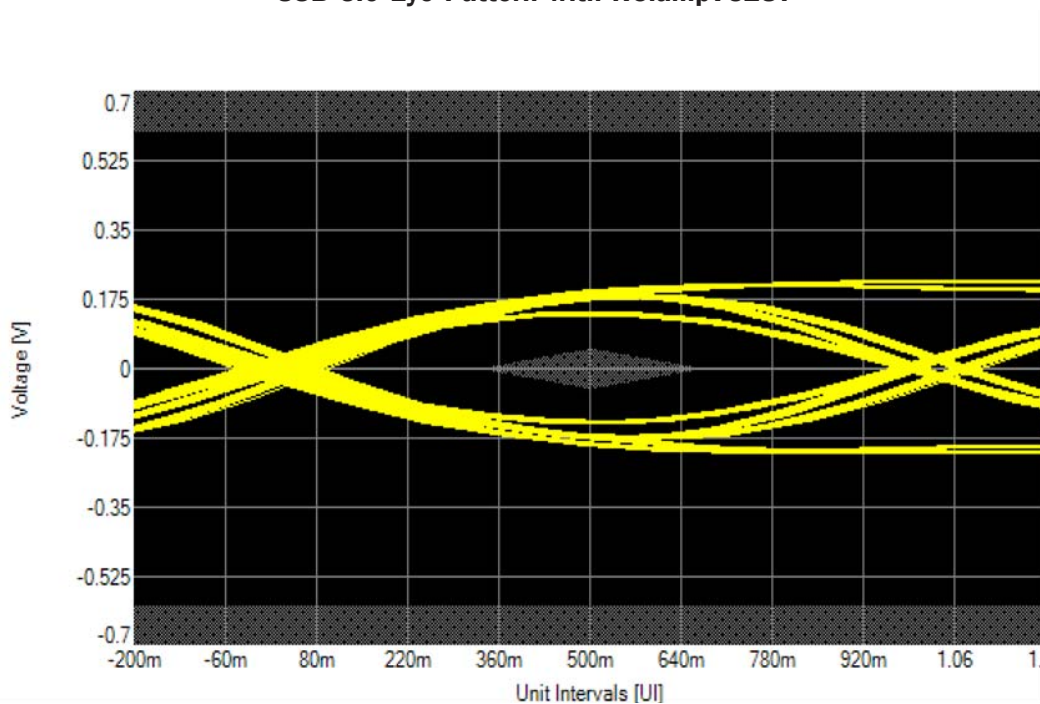

**PROTECTION PRODUCTS**

Typical Characteristics (Con't)

**ESD Clamping (+8kV Contact per IEC 61000-4-2)**

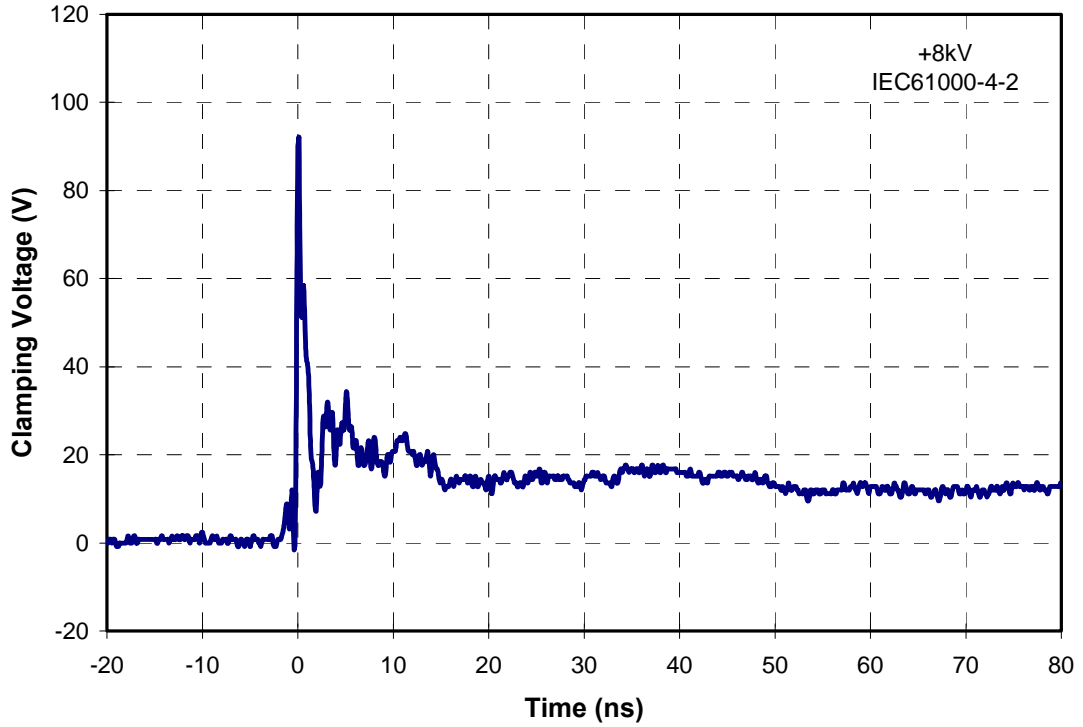

**ESD Clamping (-8kV Contact per IEC 61000-4-2)**

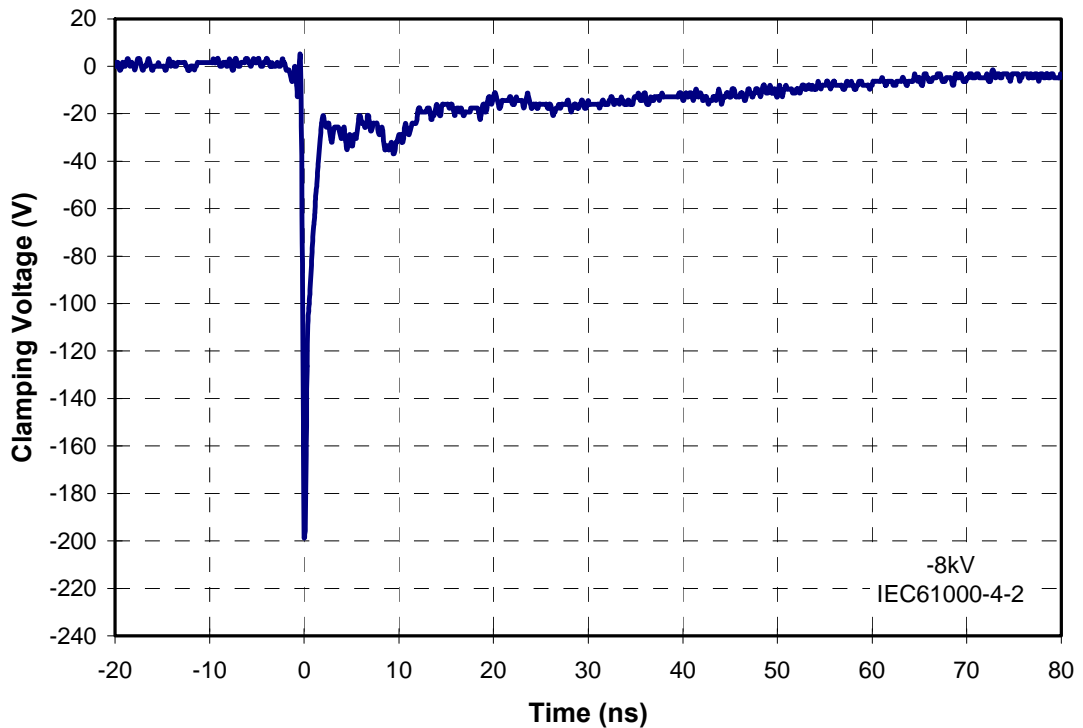

PROTECTION PRODUCTS

Typical Characteristics (Con't)

TLP Characteristic

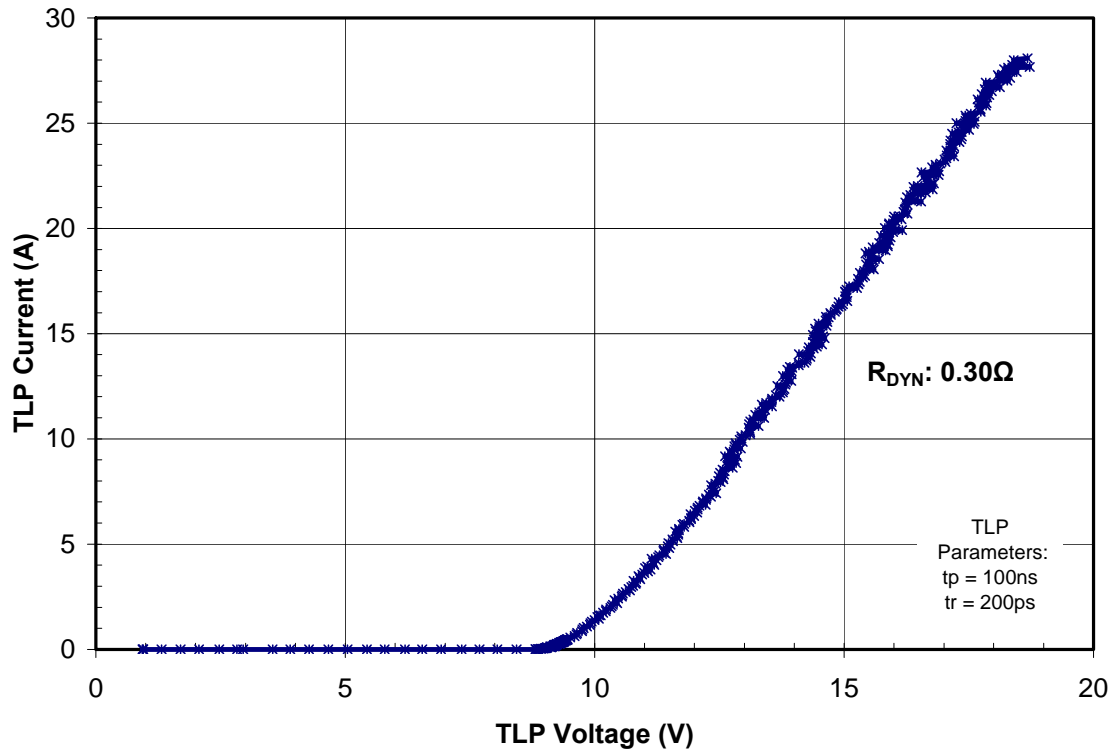



**PROTECTION PRODUCTS**

**Applications Information**

**Design Recommendations for HDMI Protection**

Adding external ESD protection to HDMI ports can be challenging. First, ESD protection devices have an inherent junction capacitance. Furthermore, adding even a small amount of capacitance will cause the impedance of the differential pair to drop. Second, large packages and land pattern requirements cause discontinuities that adversely affect signal integrity. The RClamp7528T is specifically designed for protection of high-speed interfaces such as HDMI. They present <math><0.25\text{pF}</math> capacitance between the pairs while being rated to handle  $>\pm 20\text{kV}$  ESD contact discharges ( $>\pm 25\text{kV}$  air discharge) as outlined in IEC 61000-4-2. Each device is in a leadless SLP package that is nominally 1.1mm wide. They are designed such that the traces flow straight through the device. The narrow package and flow-through design reduces discontinuities and minimizes impact on signal integrity. This becomes even more critical as signal speeds increase.

**Pin Configuration**

Figure 2 is an example of how to route the high speed differential traces through the RClamp7528T. The PCB traces enter and exit each I/O pin. The package is designed such that the trace-to-trace spacing can be kept at 0.100mm minimum when using 0.100mm wide traces. Ground is connected at pin 3.

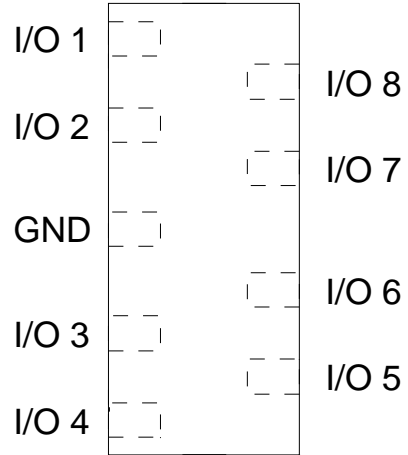

**Figure 1 - Pin Configuration (Top View)**

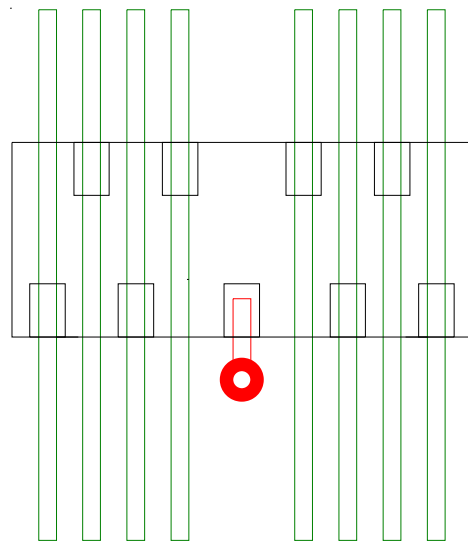

**Figure 2 - Flow through Layout Using RClamp7528T**

**PROTECTION PRODUCTS**

**Applications Information**

**Assembly Guidelines**

The small size of this device means that some care must be taken during the mounting process to insure reliable solder joint. The table below provides Semtech's recommended assembly guidelines for mounting this device. The figure at the right details Semtech's recommended aperture based on the below recommendations. Note that these are only recommendations and should serve only as a starting point for design since there are many factors that affect the assembly process. The exact manufacturing parameters will require some experimentation to get the desired solder application.

Assembly Parameter	Recommendation
Solder Stencil Design	Laser cut, Electro-polished
Aperture shape	Rectangular
Solder Stencil Thickness	0.100 mm (0.004")
Solder Paste Type	Type 3 size sphere or smaller
Solder Reflow Profile	Per JEDEC J-STD-020
PCB Solder Pad Design	Non-Solder mask defined
PCB Pad Finish	OSP OR NiAu

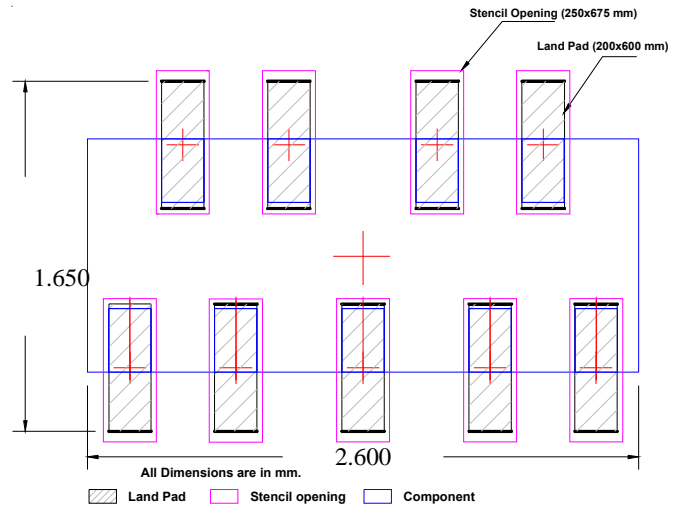

**Recommended Mounting Pattern**

PROTECTION PRODUCTS

Outline Drawing - SLP2611N9T

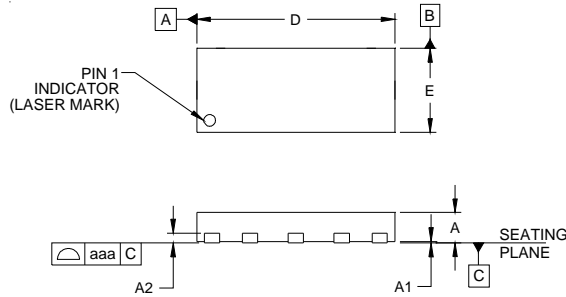

DIM	MILLIMETERS		
	MIN	NOM	MAX
A	0.37	0.40	0.43
A1	0.00	0.02	0.05
A2	(0.13)		
b	0.15	0.20	0.25
D	2.50	2.60	2.70
E	1.00	1.10	1.20
e	0.50 BSC		
e1	0.60 BSC		
e2	0.70 BSC		
L	0.25	0.30	0.35
N	9		
aaa	0.08		
bbb	0.10		

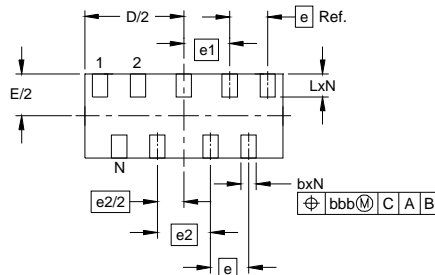

NOTES:  
 1. CONTROLLING DIMENSIONS ARE IN MILLIMETERS (ANGLES IN DEGREES).

Land Pattern - SLP2611N9T

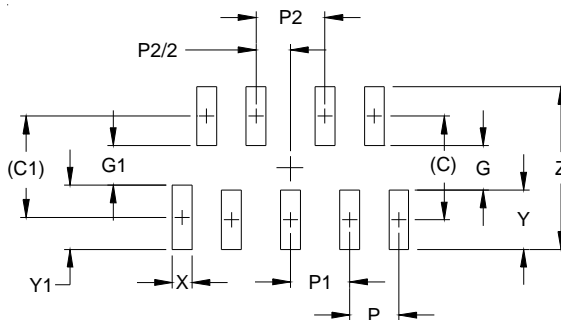

DIM	MILLIMETERS
	C
C1	(1.025)
G	0.45
G1	0.40
P	0.50
P1	0.60
P2	0.70
X	0.20
Y	0.60
Y1	0.65
Z	1.65

NOTES:  
 1. CONTROLLING DIMENSIONS ARE IN MILLIMETERS (ANGLES IN DEGREES).  
 2. THIS LAND PATTERN IS FOR REFERENCE PURPOSES ONLY.  
 CONSULT YOUR MANUFACTURING GROUP TO ENSURE YOUR COMPANY'S MANUFACTURING GUIDELINES ARE MET.

**PROTECTION PRODUCTS**

**Marking Codes**

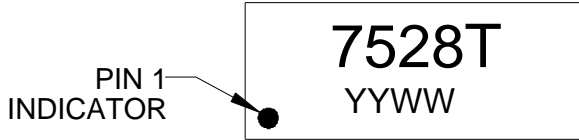

YYWW = Date Code

**Ordering Information**

Part Number	Qty per Reel	Reel Size
RClamp7528T.TNT	10,000	7 Inch

RailClamp and RClamp are trademarks of Semtech Corporation.

**Carrier Tape Specification**

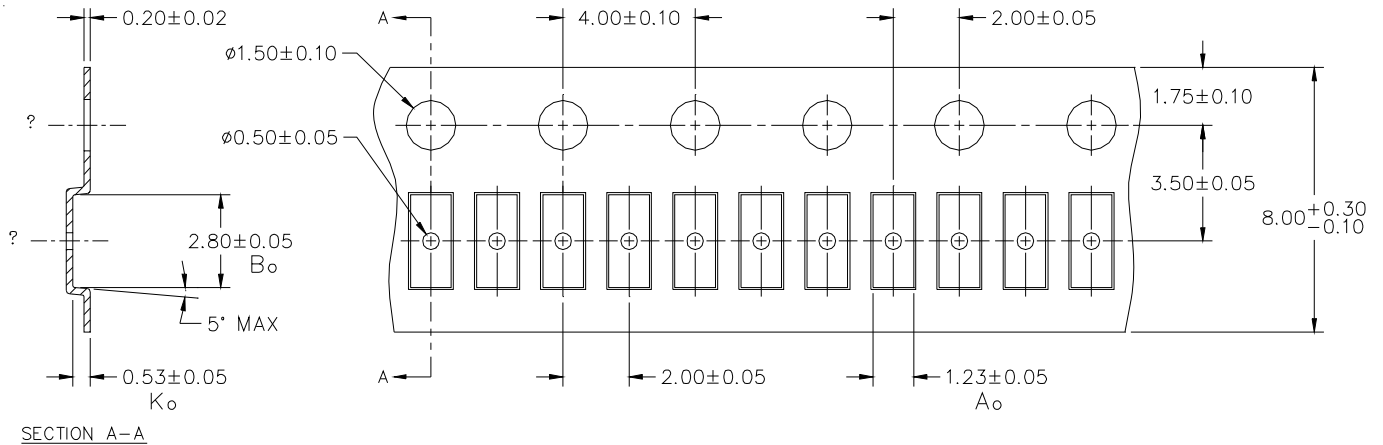

NOTES: ALL DIMENSIONS IN MILLIMETERS UNLESS OTHERWISE SPECIFIED.

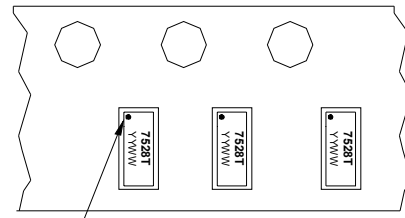

Pin 1 Location (Towards Sprocket Holes)

→  
User Direction of feed

**Device Orientation in Tape**

**Contact Information**

Semtech Corporation  
 Protection Products Division  
 200 Flynn Road, Camarillo, CA 93012  
 Phone: (805)498-2111 FAX (805)498-3804