



August 2015

# FCPF2250N80Z

## N-Channel SuperFET<sup>®</sup> II MOSFET

800 V, 3.5 A, 2.25  $\Omega$

### Features

- $R_{DS(on)} = 1.8 \Omega$  (Typ.)
- Ultra Low Gate Charge (Typ.  $Q_g = 11$  nC)
- Low  $E_{oss}$  (Typ. 1.1  $\mu$ J @ 400V)
- Low Effective Output Capacitance (Typ.  $C_{oss(eff.)} = 51$  pF)
- 100% Avalanche Tested
- RoHS Compliant
- ESD Improved Capability

### Applications

- AC - DC Power Supply
- LED Lighting

### Description

SuperFET<sup>®</sup> II MOSFET is Fairchild Semiconductor's brand-new high voltage super-junction (SJ) MOSFET family that is utilizing charge balance technology for outstanding low on-resistance and lower gate charge performance. This technology is tailored to minimize conduction loss, provide superior switching performance, dv/dt rate and higher avalanche energy. Consequently, SuperFET II MOSFET is very suitable for the switching power applications such as Audio, Laptop adapter, Lighting, ATX power and industrial power applications.

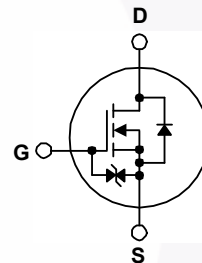
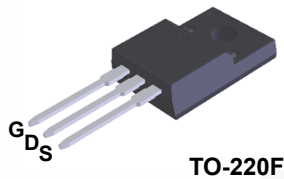

### Absolute Maximum Ratings $T_C = 25^\circ\text{C}$ unless otherwise noted.

| Symbol         | Parameter  | FCPF2250N80Z                               | Unit             |
|----------------|--|--|------------------|
| $V_{DSS}$      | Drain to Source Voltage  | 800  | V                |
| $V_{GSS}$      | Gate to Source Voltage   | - DC                                       | $\pm 20$         |
|                |  | - AC (f > 1 Hz)                            | $\pm 30$         |
| $I_D$          | Drain Current  | - Continuous ( $T_C = 25^\circ\text{C}$ )  | 3.5*             |
|                |  | - Continuous ( $T_C = 100^\circ\text{C}$ ) | 2.2*             |
| $I_{DM}$       | Drain Current  | - Pulsed (Note 1)                          | 6.5*             |
| $E_{AS}$       | Single Pulsed Avalanche Energy (Note 2)                              | 21.6                                       | mJ               |
| $I_{AR}$       | Avalanche Current (Note 1)   | 0.52                                       | A                |
| $E_{AR}$       | Repetitive Avalanche Energy (Note 1)                                 | 0.22                                       | mJ               |
| dv/dt          | MOSFET dv/dt   | 100  | V/ns             |
|                | Peak Diode Recovery dv/dt (Note 3)                                   | 20   |                  |
| $P_D$          | Power Dissipation  | ( $T_C = 25^\circ\text{C}$ )               | 21.9             |
|                |  | - Derate Above $25^\circ\text{C}$          | 0.18             |
| $T_J, T_{STG}$ | Operating and Storage Temperature Range                              | -55 to +150                                | $^\circ\text{C}$ |
| $T_L$          | Maximum Lead Temperature for Soldering, 1/8" from Case for 5 Seconds | 300  | $^\circ\text{C}$ |

\*Drain current limited by maximum junction temperature, with heatsink.

### Thermal Characteristics

| Symbol          | Parameter                                     | FCPF2250N80Z | Unit                      |
|-----------------|---|--------------|---------------------------|
| $R_{\theta JC}$ | Thermal Resistance, Junction to Case, Max.    | 5.7          | $^\circ\text{C}/\text{W}$ |
| $R_{\theta JA}$ | Thermal Resistance, Junction to Ambient, Max. | 62.5         |                           |

## Package Marking and Ordering Information

| Part Number  | Top Mark     | Package | Packing Method | Reel Size | Tape Width | Quantity |
|--------------|--------------|---------|----------------|-----------|------------|----------|
| FCPF2250N80Z | FCPF2250N80Z | TO-220F | Tube           | N/A       | N/A        | 50 units |

## Electrical Characteristics $T_C = 25^\circ\text{C}$ unless otherwise noted.

| Symbol | Parameter | Test Conditions | Min. | Typ. | Max. | Unit |
|--------|-----------|-----------------|------|------|------|------|
|--------|-----------|-----------------|------|------|------|------|

### Off Characteristics

|                                |   |   |     |      |          |                     |
|--------------------------------|---|---|-----|------|----------|---------------------|
| $BV_{DSS}$                     | Drain to Source Breakdown Voltage         | $V_{GS} = 0\text{ V}, I_D = 1\text{ mA}, T_J = 25^\circ\text{C}$      | 800 | -    | -        | V                   |
| $\Delta BV_{DSS} / \Delta T_J$ | Breakdown Voltage Temperature Coefficient | $I_D = 1\text{ mA}$ , Referenced to $25^\circ\text{C}$                | -   | 0.85 | -        | V/ $^\circ\text{C}$ |
| $I_{DSS}$                      | Zero Gate Voltage Drain Current           | $V_{DS} = 800\text{ V}, V_{GS} = 0\text{ V}$                          | -   | -    | 25       | $\mu\text{A}$       |
|                                |   | $V_{DS} = 640\text{ V}, V_{GS} = 0\text{ V}, T_C = 125^\circ\text{C}$ | -   | -    | 250      | $\mu\text{A}$       |
| $I_{GSS}$                      | Gate to Body Leakage Current              | $V_{GS} = \pm 20\text{ V}, V_{DS} = 0\text{ V}$                       | -   | -    | $\pm 10$ | $\mu\text{A}$       |

### On Characteristics

|              |                                      |  |     |      |      |          |
|--------------|--------------------------------------|--|-----|------|------|----------|
| $V_{GS(th)}$ | Gate Threshold Voltage               | $V_{GS} = V_{DS}, I_D = 0.26\text{ mA}$    | 2.5 | -    | 4.5  | V        |
| $R_{DS(on)}$ | Static Drain to Source On Resistance | $V_{GS} = 10\text{ V}, I_D = 1.3\text{ A}$ | -   | 1.8  | 2.25 | $\Omega$ |
| $g_{FS}$     | Forward Transconductance             | $V_{DS} = 20\text{ V}, I_D = 1.3\text{ A}$ | -   | 2.28 | -    | S        |

### Dynamic Characteristics

|                 |                               |   |   |      |     |          |
|-----------------|-------------------------------|---|---|------|-----|----------|
| $C_{iss}$       | Input Capacitance             | $V_{DS} = 100\text{ V}, V_{GS} = 0\text{ V}, f = 1\text{ MHz}$                | - | 440  | 585 | pF       |
| $C_{oss}$       | Output Capacitance            |   | - | 16   | 22  | pF       |
| $C_{rss}$       | Reverse Transfer Capacitance  |   | - | 0.75 | -   | pF       |
| $C_{oss}$       | Output Capacitance            | $V_{DS} = 480\text{ V}, V_{GS} = 0\text{ V}, f = 1\text{ MHz}$                | - | 8.4  | -   | pF       |
| $C_{oss(eff.)}$ | Effective Output Capacitance  | $V_{DS} = 0\text{ V to } 480\text{ V}, V_{GS} = 0\text{ V}$                   | - | 51   | -   | pF       |
| $Q_{g(tot)}$    | Total Gate Charge at 10V      | $V_{DS} = 640\text{ V}, I_D = 2.6\text{ A}, V_{GS} = 10\text{ V}$<br>(Note 4) | - | 11   | 14  | nC       |
| $Q_{gs}$        | Gate to Source Gate Charge    |   | - | 2.2  | -   | nC       |
| $Q_{gd}$        | Gate to Drain "Miller" Charge |   | - | 4.3  | -   | nC       |
| ESR             | Equivalent Series Resistance  | $f = 1\text{ MHz}$  | - | 2.8  | -   | $\Omega$ |

### Switching Characteristics

|              |                     |  |   |     |    |    |
|--------------|---------------------|--|---|-----|----|----|
| $t_{d(on)}$  | Turn-On Delay Time  | $V_{DD} = 400\text{ V}, I_D = 2.6\text{ A}, V_{GS} = 10\text{ V}, R_g = 4.7\text{ }\Omega$<br>(Note 4) | - | 11  | 32 | ns |
| $t_r$        | Turn-On Rise Time   |  | - | 6.7 | 23 | ns |
| $t_{d(off)}$ | Turn-Off Delay Time |  | - | 26  | 62 | ns |
| $t_f$        | Turn-Off Fall Time  |  | - | 8.7 | 27 | ns |

### Drain-Source Diode Characteristics

|          |  |  |   |     |     |               |
|----------|--|--|---|-----|-----|---------------|
| $I_S$    | Maximum Continuous Drain to Source Diode Forward Current | -  | - | 3.5 | A   |               |
| $I_{SM}$ | Maximum Pulsed Drain to Source Diode Forward Current     | -  | - | 6.5 | A   |               |
| $V_{SD}$ | Drain to Source Diode Forward Voltage                    | $V_{GS} = 0\text{ V}, I_{SD} = 2.6\text{ A}$                                     | - | -   | 1.2 | V             |
| $t_{rr}$ | Reverse Recovery Time                                    | $V_{GS} = 0\text{ V}, I_{SD} = 2.6\text{ A}, di_F/dt = 100\text{ A}/\mu\text{s}$ | - | 260 | -   | ns            |
| $Q_{rr}$ | Reverse Recovery Charge                                  |  | - | 2.2 | -   | $\mu\text{C}$ |

#### Notes:

1. Repetitive rating: pulse width limited by maximum junction temperature.
2.  $I_{AS} = 0.52\text{ A}, R_G = 25\text{ }\Omega$ , starting  $T_J = 25^\circ\text{C}$
3.  $I_{SD} \leq 3.5\text{ A}, di/dt \leq 200\text{ A}/\mu\text{s}, V_{DD} \leq BV_{DSS}$ , starting  $T_J = 25^\circ\text{C}$
4. Essentially independent of operating temperature typical characteristic.

## Typical Performance Characteristics

**Figure 1. On-Region Characteristics**

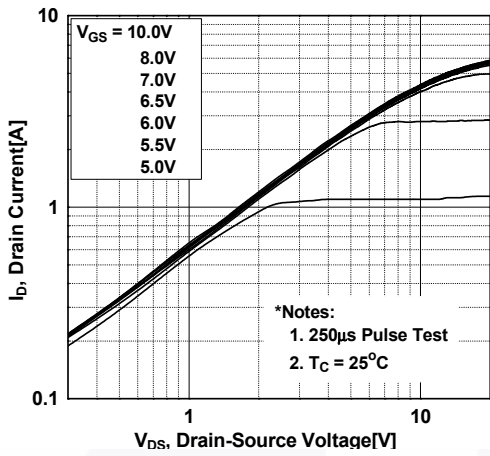

**Figure 2. Transfer Characteristics**

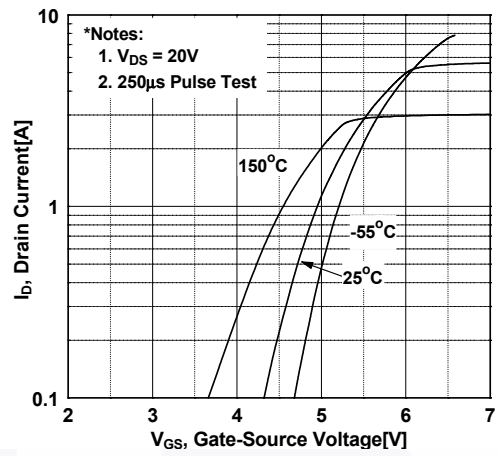

**Figure 3. On-Resistance Variation vs. Drain Current and Gate Voltage**

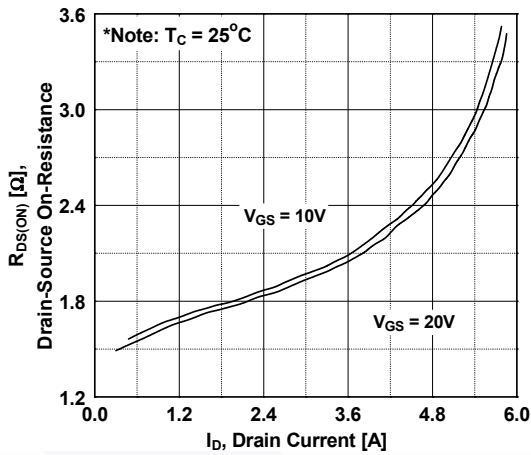

**Figure 4. Body Diode Forward Voltage Variation vs. Source Current and Temperature**

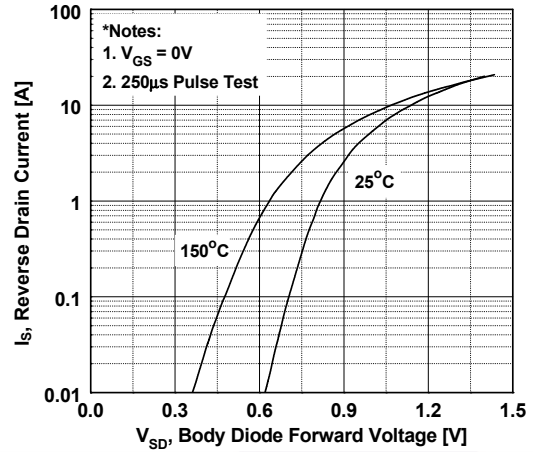

**Figure 5. Capacitance Characteristics**

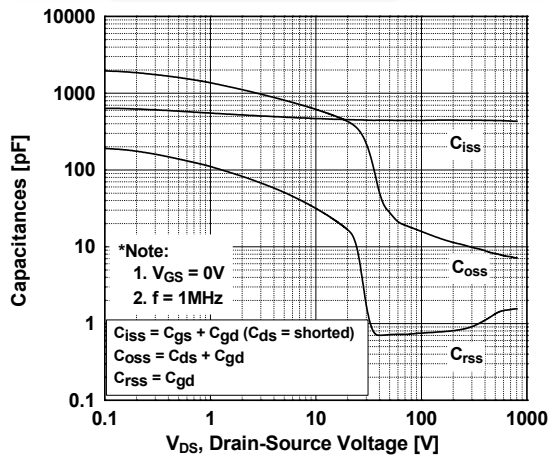

**Figure 6. Gate Charge Characteristics**

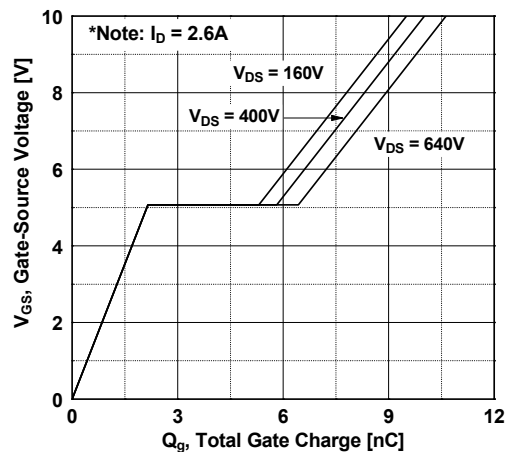

Typical Performance Characteristics (Continued)

Figure 7. Breakdown Voltage Variation vs. Temperature

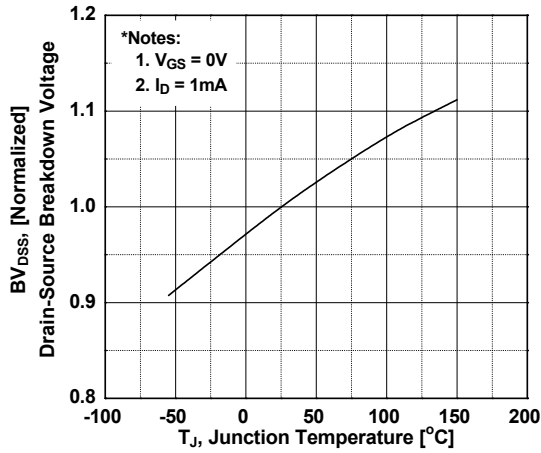

Figure 8. On-Resistance Variation vs. Temperature

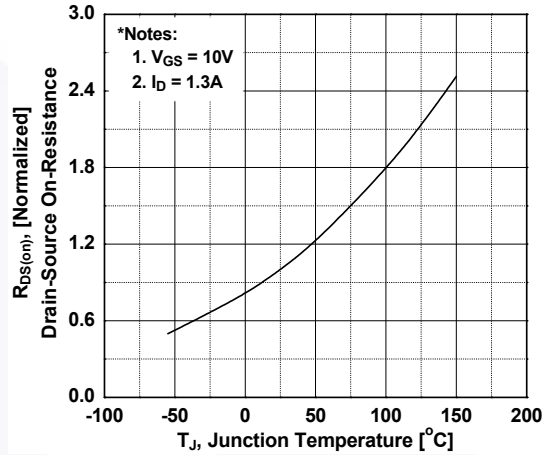

Figure 9. Maximum Safe Operating Area

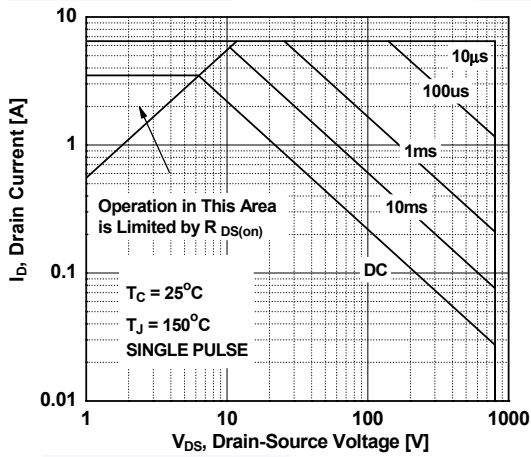

Figure 10. Maximum Drain Current vs. Case Temperature

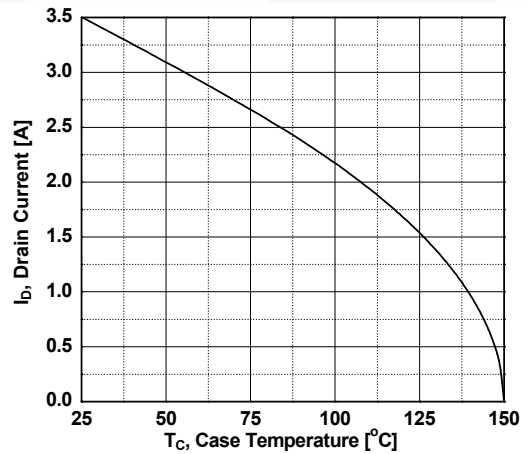
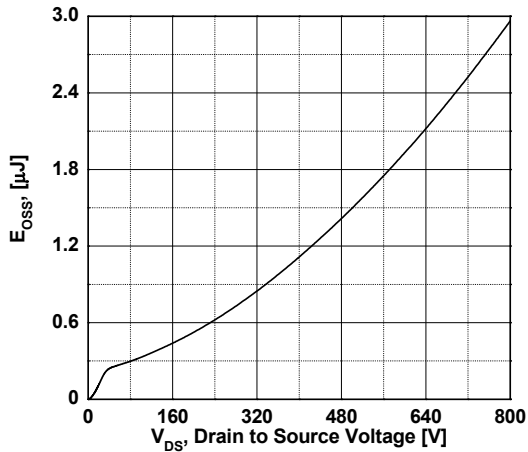
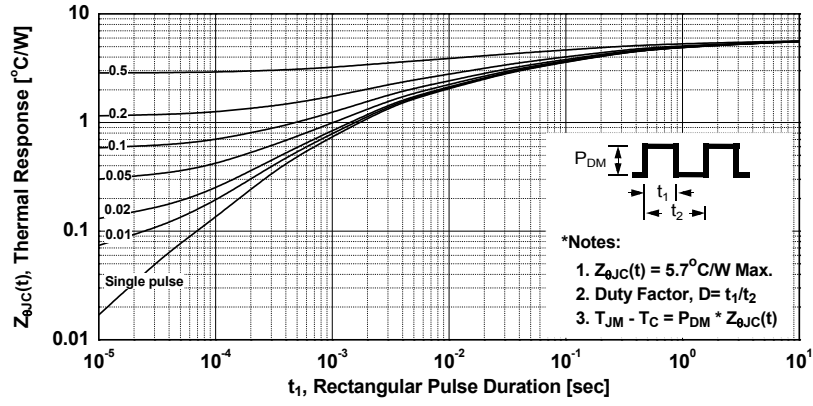

Figure 11. Eoss vs. Drain to Source Voltage



Typical Performance Characteristics (Continued)

Figure 12. Transient Thermal Response Curve



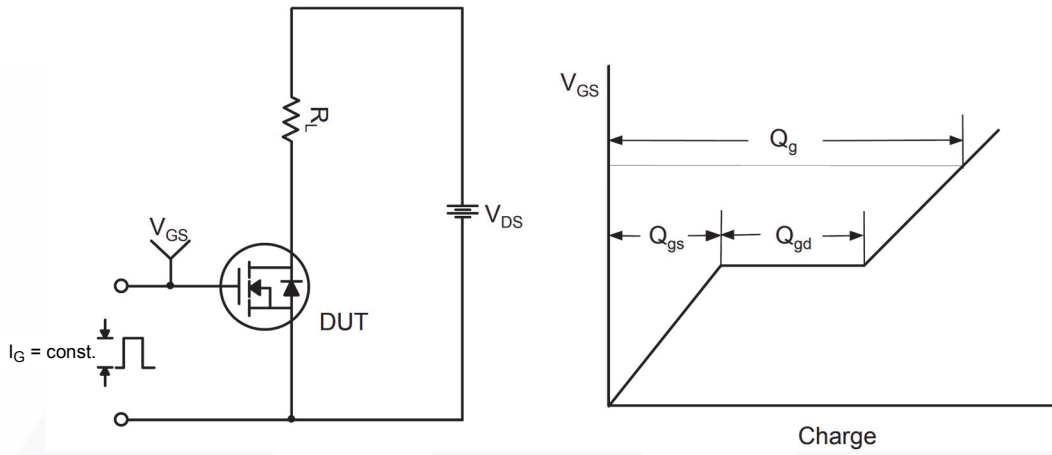

**Figure 13. Gate Charge Test Circuit & Waveform**



**Figure 14. Resistive Switching Test Circuit & Waveforms**



**Figure 15. Unclamped Inductive Switching Test Circuit & Waveforms**



Figure 16. Peak Diode Recovery  $dv/dt$  Test Circuit & Waveforms

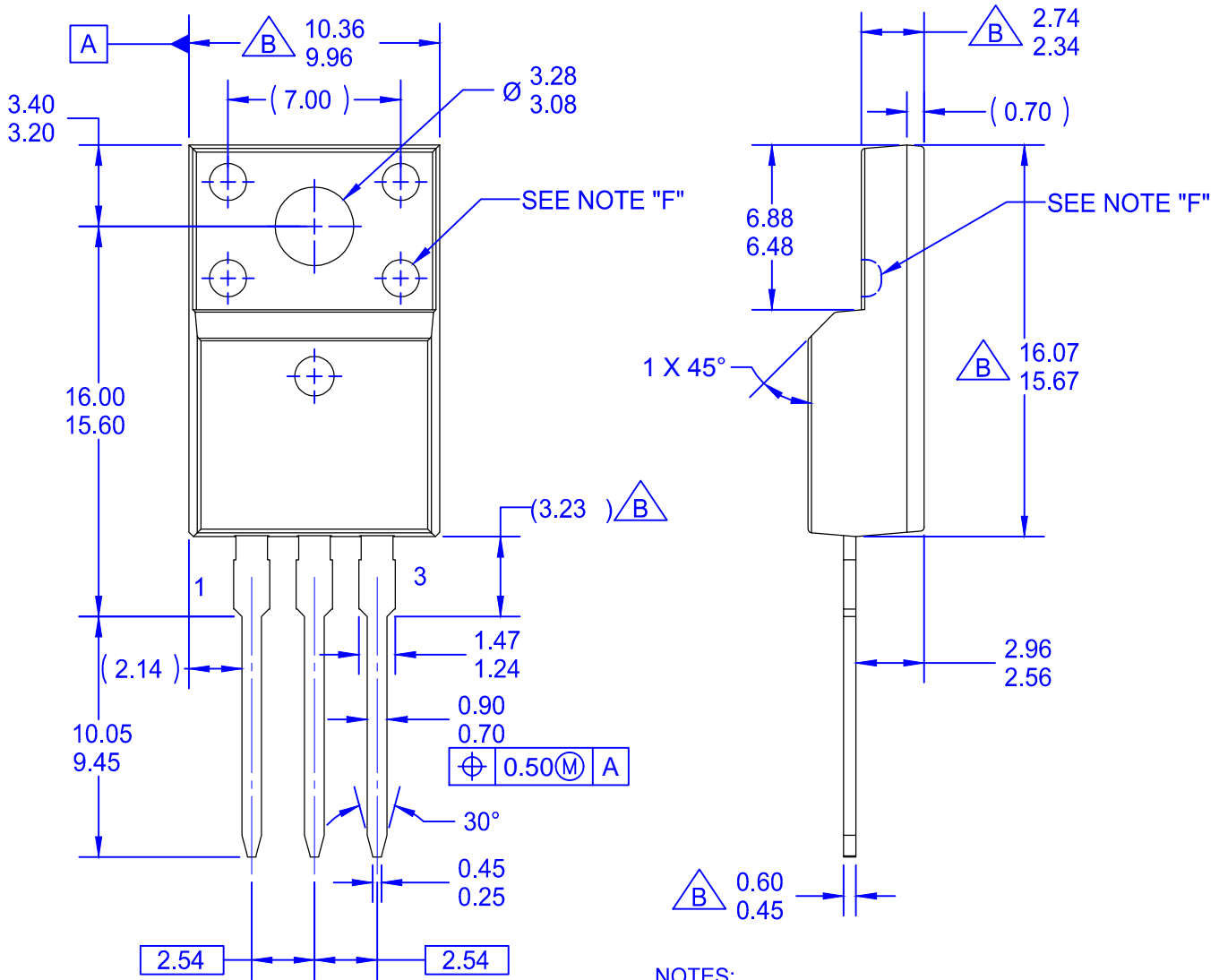

⊕ 0.50 (M) A

NOTES:

- A. EXCEPT WHERE NOTED CONFORMS TO EIAJ SC91A.
- B. DOES NOT COMPLY EIAJ STD. VALUE.
- C. ALL DIMENSIONS ARE IN MILLIMETERS.
- D. DIMENSIONS ARE EXCLUSIVE OF BURRS, MOLD FLASH AND TIE BAR PROTRUSIONS.
- E. DIMENSION AND TOLERANCE AS PER ASME Y14.5-1994.
- F. OPTION 1 - WITH SUPPORT PIN HOLE.  
OPTION 2 - NO SUPPORT PIN HOLE.
- G. DRAWING FILE NAME: TO220M03REV4







**TRADEMARKS**

The following includes registered and unregistered trademarks and service marks, owned by Fairchild Semiconductor and/or its global subsidiaries, and is not intended to be an exhaustive list of all such trademarks.

- |                          |  |                                       |                  |
|--------------------------|--|---------------------------------------|------------------|
| AccuPower™               | F-PFS™   | OPTOPLANAR®                           | SYSTEM GENERAL®  |
| AttitudeEngine™          | FRFET®   | Power Supply WebDesigner™             | TinyBoost®       |
| Awinda®                  | Global Power Resource <sup>SM</sup>            | PowerTrench®                          | TinyBuck®        |
| AX-CAP®*                 | GreenBridge™                                   | PowerXS™                              | TinyCalc™        |
| BitSiC™                  | Green FPS™                                     | Programmable Active Droop™            | TinyLogic®       |
| Build it Now™            | Green FPS™ e-Series™                           | QFET®                                 | TINYOPTO™        |
| CorePLUS™                | Gmax™  | QS™                                   | TinyPower™       |
| CorePOWER™               | GTO™   | Quiet Series™                         | TinyPWM™         |
| CROSSVOL™                | IntelliMAX™                                    | RapidConfigure™                       | TinyWire™        |
| CTL™                     | ISOPLANAR™                                     | Saving our world, 1mW/W/kW at a time™ | TranSiC™         |
| Current Transfer Logic™  | Making Small Speakers Sound Louder and Better™ | SignalWise™                           | TriFault Detect™ |
| DEUXPEED®                | MegaBuck™                                      | SmartMax™                             | TRUECURRENT®*    |
| Dual Cool™               | MICROCOUPLER™                                  | SMART START™                          | μSerDes™         |
| EcoSPARK®                | MicroFET™                                      | Solutions for Your Success™           | UHC®             |
| EfficientMax™            | MicroPak™                                      | SPM®                                  | Ultra FRFET™     |
| ESBC™                    | MicroPak2™                                     | STEALTH™                              | UniFET™          |
| F <sup>®</sup>           | MillerDrive™                                   | SuperFET®                             | Vcx™             |
| Fairchild®               | MotionMax™                                     | SuperSOT™-3                           | VisualMax™       |
| Fairchild Semiconductor® | MotionGrid®                                    | SuperSOT™-6                           | VoltagePlus™     |
| FACT Quiet Series™       | MTi®   | SuperSOT™-8                           | Xs™              |
| FACT®                    | MTx®   | SupreMOS®                             | Xsens™           |
| FastvCore™               | MVN®   | SyncFET™                              | 仙童®              |
| FETBench™                | mWSaver®                                       | Sync-Lock™                            |                  |
| FPS™                     | OptoHiT™                                       |                                       |                  |
|                          | OPTOLOGIC®                                     |                                       |                  |

\* Trademarks of System General Corporation, used under license by Fairchild Semiconductor.

**DISCLAIMER**

FAIRCHILD SEMICONDUCTOR RESERVES THE RIGHT TO MAKE CHANGES WITHOUT FURTHER NOTICE TO ANY PRODUCTS HEREIN TO IMPROVE RELIABILITY, FUNCTION, OR DESIGN. TO OBTAIN THE LATEST, MOST UP-TO-DATE DATASHEET AND PRODUCT INFORMATION, VISIT OUR WEBSITE AT [HTTP://WWW.FAIRCHILDSEMI.COM](http://www.fairchildsemi.com). FAIRCHILD DOES NOT ASSUME ANY LIABILITY ARISING OUT OF THE APPLICATION OR USE OF ANY PRODUCT OR CIRCUIT DESCRIBED HEREIN; NEITHER DOES IT CONVEY ANY LICENSE UNDER ITS PATENT RIGHTS, NOR THE RIGHTS OF OTHERS. THESE SPECIFICATIONS DO NOT EXPAND THE TERMS OF FAIRCHILD'S WORLDWIDE TERMS AND CONDITIONS, SPECIFICALLY THE WARRANTY THEREIN, WHICH COVERS THESE PRODUCTS.

**AUTHORIZED USE**

Unless otherwise specified in this data sheet, this product is a standard commercial product and is not intended for use in applications that require extraordinary levels of quality and reliability. This product may not be used in the following applications, unless specifically approved in writing by a Fairchild officer: (1) automotive or other transportation, (2) military/aerospace, (3) any safety critical application – including life critical medical equipment – where the failure of the Fairchild product reasonably would be expected to result in personal injury, death or property damage. Customer's use of this product is subject to agreement of this Authorized Use policy. In the event of an unauthorized use of Fairchild's product, Fairchild accepts no liability in the event of product failure. In other respects, this product shall be subject to Fairchild's Worldwide Terms and Conditions of Sale, unless a separate agreement has been signed by both Parties.

**ANTI-COUNTERFEITING POLICY**

Fairchild Semiconductor Corporation's Anti-Counterfeiting Policy. Fairchild's Anti-Counterfeiting Policy is also stated on our external website, [www.fairchildsemi.com](http://www.fairchildsemi.com), under Terms of Use

Counterfeiting of semiconductor parts is a growing problem in the industry. All manufacturers of semiconductor products are experiencing counterfeiting of their parts. Customers who inadvertently purchase counterfeit parts experience many problems such as loss of brand reputation, substandard performance, failed applications, and increased cost of production and manufacturing delays. Fairchild is taking strong measures to protect ourselves and our customers from the proliferation of counterfeit parts. Fairchild strongly encourages customers to purchase Fairchild parts either directly from Fairchild or from Authorized Fairchild Distributors who are listed by country on our web page cited above. Products customers buy either from Fairchild directly or from Authorized Fairchild Distributors are genuine parts, have full traceability, meet Fairchild's quality standards for handling and storage and provide access to Fairchild's full range of up-to-date technical and product information. Fairchild and our Authorized Distributors will stand behind all warranties and will appropriately address any warranty issues that may arise. Fairchild will not provide any warranty coverage or other assistance for parts bought from Unauthorized Sources. Fairchild is committed to combat this global problem and encourage our customers to do their part in stopping this practice by buying direct or from authorized distributors.

**PRODUCT STATUS DEFINITIONS**

**Definition of Terms**

| Datasheet Identification | Product Status        | Definition  |
|--------------------------|-----------------------|---|
| Advance Information      | Formative / In Design | Datasheet contains the design specifications for product development. Specifications may change in any manner without notice.   |
| Preliminary              | First Production      | Datasheet contains preliminary data; supplementary data will be published at a later date. Fairchild Semiconductor reserves the right to make changes at any time without notice to improve design. |
| No Identification Needed | Full Production       | Datasheet contains final specifications. Fairchild Semiconductor reserves the right to make changes at any time without notice to improve the design.   |
| Obsolete                 | Not In Production     | Datasheet contains specifications on a product that is discontinued by Fairchild Semiconductor. The datasheet is for reference information only.  |