

600V High voltage High & Low-side, Gate Driver

BS2100F

General Description

The BS2100F is a monolithic high and low side gate drive IC, which can drive high speed power MOSFET and IGBT driver with bootstrap operation.

The floating channel can be used to driven an N-channel power MOSFET or IGBT in the high side configuration which operates up to 600V.

The logic inputs can be used 3.3V and 5.0V.

The Under Voltage Lockout (UVLO) circuit prevents malfunction when VCC and VBS are lower than the specified threshold voltage.

Features

- Floating Channels for Bootstrap Operation to +600V
- Gate drive supply range from 10V to 18V
- Built-in Under Voltage Lockout for Both Channels
- 3.3V and 5.0V Input Logic Compatible
- Matched Propagation Delay for Both Channels
- Output in phase with input

Applications

- MOSFET and IGBT high side driver applications

Key Specifications

- High-side floating supply voltage: 600V
- Output voltage range: 10V to 18V
- Min Output Current I_{o+}/I_{o-} : 60mA/130mA
- Turn-on/off time: 220ns(Typ)
- Dead time: 160ns(Typ)
- Delay Matching: 50ns(Max)
- Offset supply leakage current: 50 μ A (Max)
- Operating temperature range: -40°C to +125°C

Package

SOP-8 5.00mm x 6.20mm x 1.50mm



Typical Application Circuits

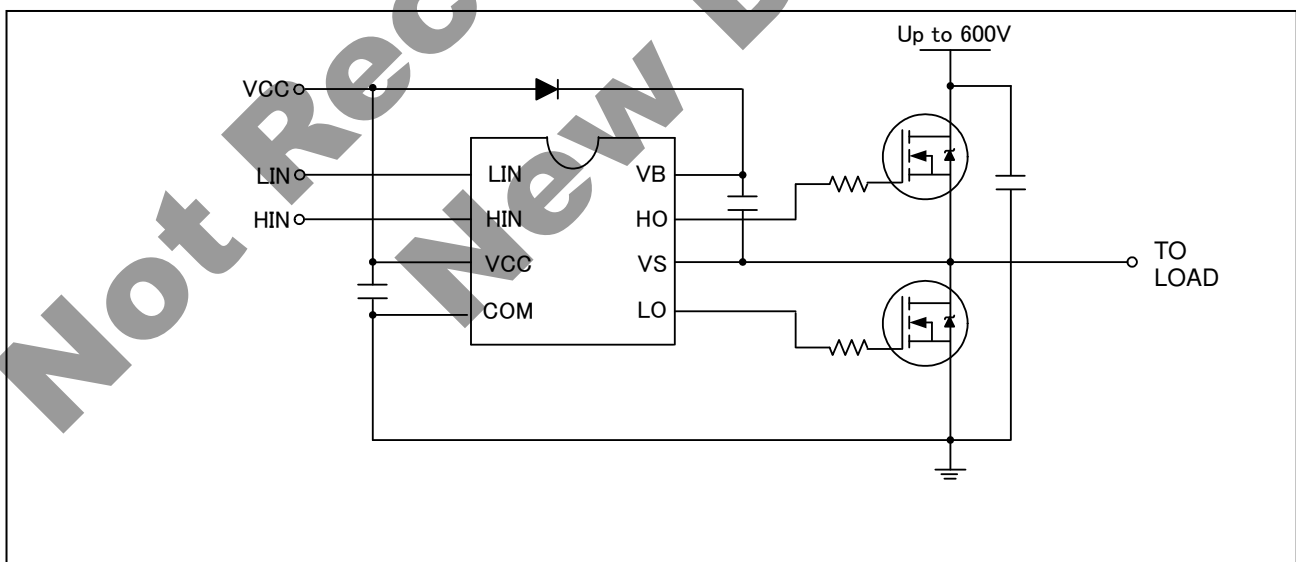

Figure 1. Typical Application Circuit

Pin Configuration

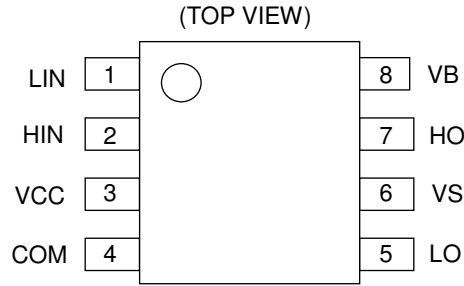

Figure 2. Pin Configuration

Pin Description

| Pin No. | Symbol | Function |
|---------|--------|--|
| 1 | LIN | Logic input for low side gate driver output |
| 2 | HIN | Logic input for high side gate driver output |
| 3 | VCC | Low side supply voltage |
| 4 | COM | Low side return |
| 5 | LO | Low side gate drive output |
| 6 | VS | High side floating supply return |
| 7 | HO | High side gate drive output |
| 8 | VB | High side floating supply |

Block Diagram

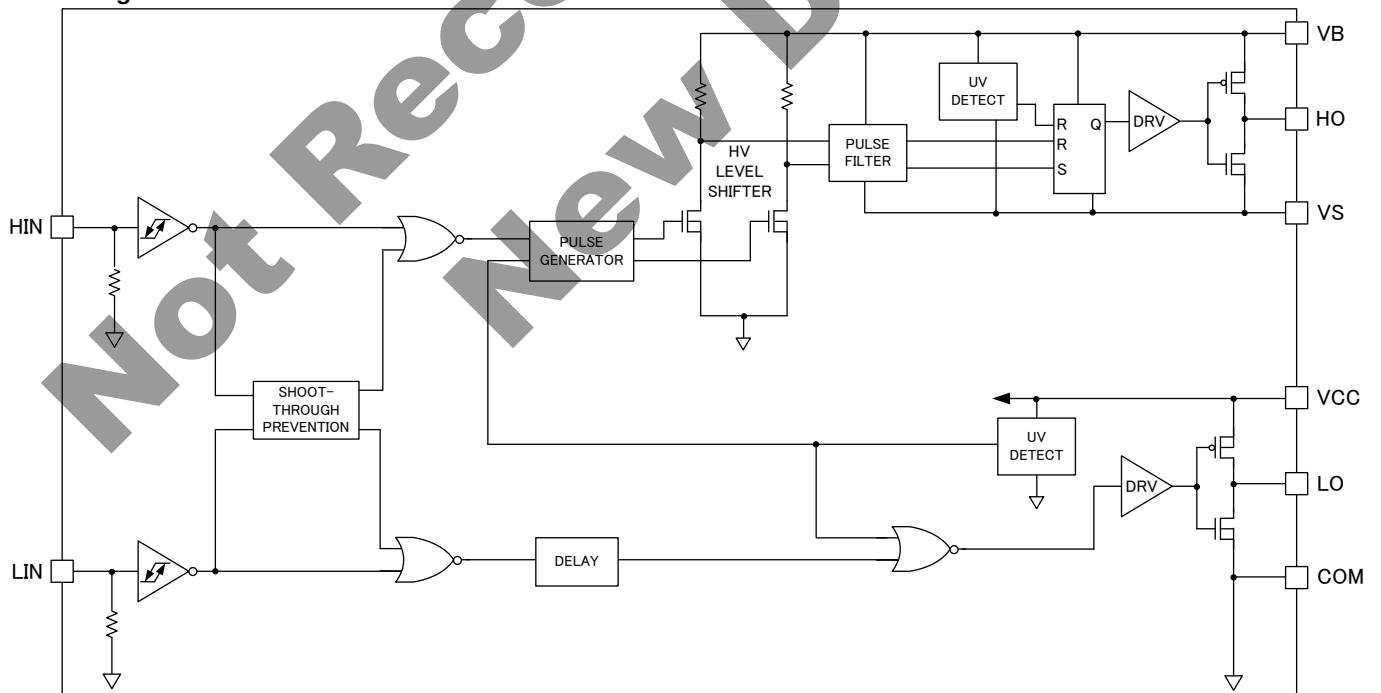

Figure 3. Functional Block Diagram

Absolute Maximum Ratings (Ta=25°C)

| Parameter | Symbol | Min | Max | Unit |
|---|---------------------|---------------------|--------------------------|------|
| High side offset voltage | V _S | V _B -20 | V _B +0.3 | V |
| High side floating supply voltage | V _B | -0.3 | +620 | V |
| High side floating output voltage HO | V _{HO} | V _S -0.3 | V _B +0.3 | V |
| Low side and logic fixed supply voltage | V _{CC} | -0.3 | 20 | V |
| Low side output voltage LO | V _{LO} | -0.3 | V _{CC} +0.3 | V |
| Logic input voltage (HIN, LIN) | V _{IN} | -0.3 | V _{CC} +0.3 | V |
| Logic ground | Com | V _{CC} -20 | V _{CC} +0.3 | V |
| Allowable offset voltage SLEW RATE | dV _S /dt | - | 50 | V/ns |
| Power Dissipation | P _d | - | 0.67 ^(Note 1) | W |
| Junction temperature | T _{jmax} | - | 150 | °C |
| Storage temperature | T _{stg} | -55 | +150 | °C |

(Note 1) Derating is done 5.4 mW/°C for operating above Ta≥25°C (Mount on 4-layer 70.0mm x 70.0mm x 1.6mm board)

Caution: Operating the IC over the absolute maximum ratings may damage the IC. The damage can either be a short circuit between pins or an open circuit between pins and the internal circuitry. Therefore, it is important to consider circuit protection measures, such as adding a fuse, in case the IC is operated over the absolute maximum ratings.

Recommended Operating Ratings

| Parameter | Symbol | Min | Max | Unit |
|--|-----------------|--------------------|--------------------|------|
| High side floating supply voltage | V _B | V _S +10 | V _S +18 | V |
| High side floating supply offset voltage | V _S | - | 600 | V |
| High side (HO) output voltage | V _{HO} | V _S | V _B | V |
| Low side (LO) output voltage | V _{LO} | Com | V _{CC} | V |
| Logic input voltage (HIN, LIN) | V _{IN} | Com | V _{CC} | V |
| Low side supply voltage | V _{CC} | 10 | 18 | V |
| Ambient temperature | T _A | -40 | +125 | °C |

DC Operation Electrical Characteristics(Unless otherwise specified: $T_a=25^\circ\text{C}$, $V_{CC}=15\text{V}$, $V_{BS}=15\text{V}$, $V_S=\text{COM}$, $C_L=1000\text{pF}$)

| Parameter | Symbol | Limits | | | Unit | Conditions |
|--|----------------------------|--------|-----|-----|---------------|--|
| | | Min | Typ | Max | | |
| V_{CC} and V_{BS} supply undervoltage positive going threshold | V_{CCUV+} V_{BSUV+} | 8 | 8.9 | 9.8 | V | |
| V_{CC} and V_{BS} supply undervoltage negative going threshold | V_{CCUV-} V_{BSUV-} | 7.4 | 8.2 | 9 | | |
| V_{CC} supply undervoltage lockout hysteresis | V_{CCUVH} V_{BSUVH} | 0.3 | 0.7 | - | | |
| Offset supply leakage current | I_{LK} | - | - | 50 | μA | $V_B = V_S = 600\text{V}$ |
| Quiescent V_{BS} supply current | I_{QBS} | 20 | 60 | 150 | | $V_{IN} = 0\text{V}$ or 5V |
| Quiescent V_{CC} supply current | I_{QCC} | 50 | 120 | 240 | | $V_{IN} = 0\text{V}$ or 5V |
| Logic "1" input voltage | V_{IH} | 2.6 | - | - | V | |
| Logic "0" input voltage | V_{IL} | - | - | 1.0 | | |
| High level output voltage, $V_{CC}(V_{BS}) - V_O$ | V_{OH} | - | - | 2.8 | | $I_O = 20\text{mA}$ |
| Low level output voltage, V_O | V_{OL} | - | - | 1.2 | | |
| Logic "1" input bias current | I_{IN+} | - | 5 | 40 | μA | $V_{IN} = 5\text{V}$ |
| Logic "0" input bias current | I_{IN-} | - | 1.0 | 2.0 | | $V_{IN} = 0\text{V}$ |
| Output high short circuit pulse current | I_{O+} | 60 | - | - | mA | $V_O = 0\text{V}$ Pulse Width $\leq 10\mu\text{s}$ |
| Output low short circuit pulsed current | I_{O-} | 130 | - | - | | $V_O = 15\text{V}$ Pulse Width $\leq 10\mu\text{s}$ |

AC Operation Electrical Characteristics(Unless otherwise specified: $T_a=25^\circ\text{C}$, $V_{CC}=15\text{V}$, $V_{BS}=15\text{V}$, $V_S=\text{COM}$, $C_L=1000\text{pF}$)

| Parameter | Symbol | Limits | | | Unit | Conditions |
|-------------------------------------|-----------|--------|-----|-----|------|------------------------------------|
| | | Min | Typ | Max | | |
| Turn-on propagation delay | t_{on} | 120 | 220 | 320 | ns | $V_S = 0\text{V}$ |
| Turn-off propagation delay | t_{off} | 130 | 220 | 330 | | $V_S = 0\text{V}$ or 600V |
| Turn-on rise time | t_r | 60 | 200 | 300 | | |
| Turn-off fall time | t_f | 20 | 100 | 170 | | |
| Dead time | DT | 80 | 160 | 240 | | |
| Delay matching, HS & LS turn-on/off | MT | - | - | 50 | | |

Typical Performance Curves

(Unless otherwise specified: $T_a=25^\circ\text{C}$, $V_{CC}=15\text{V}$, $V_{BS}=15\text{V}$, $V_S=\text{COM}$, $C_L=1000\text{pF}$)

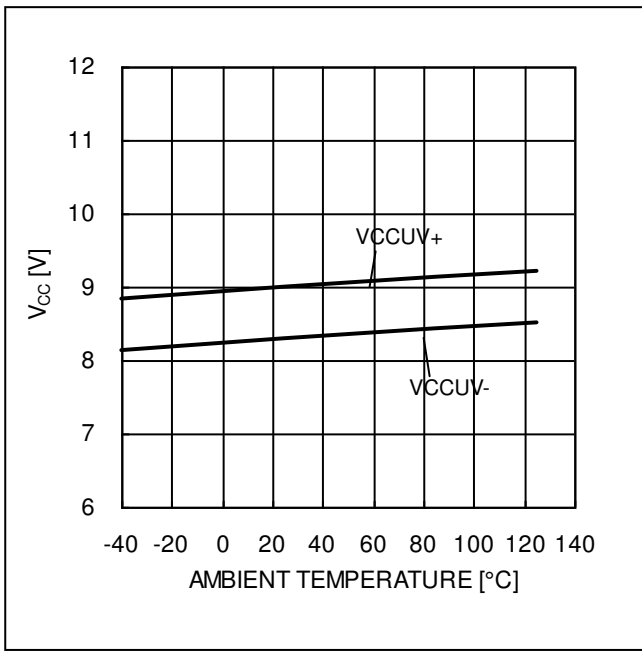

Figure 4. V_{CC} UVLO - T_a

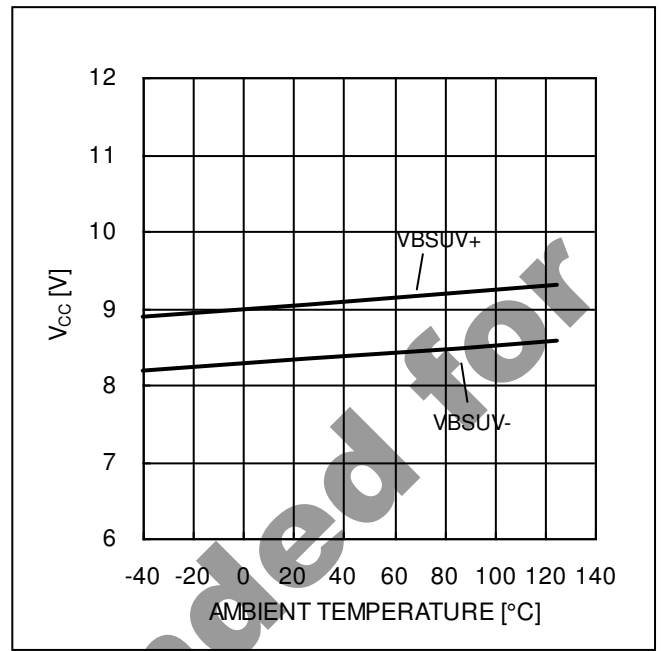

Figure 5. V_{BS} UVLO - T_a

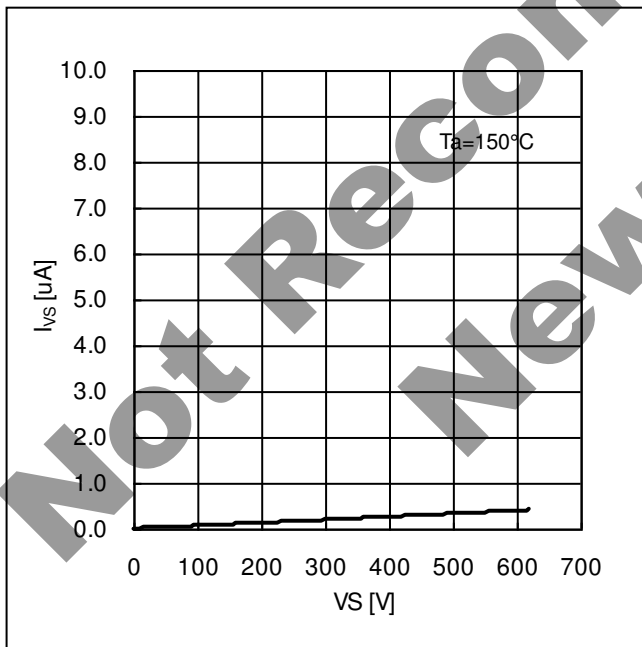

Figure 6. Offset Supply Leakage Current - V_S
($V_B=V_S$)

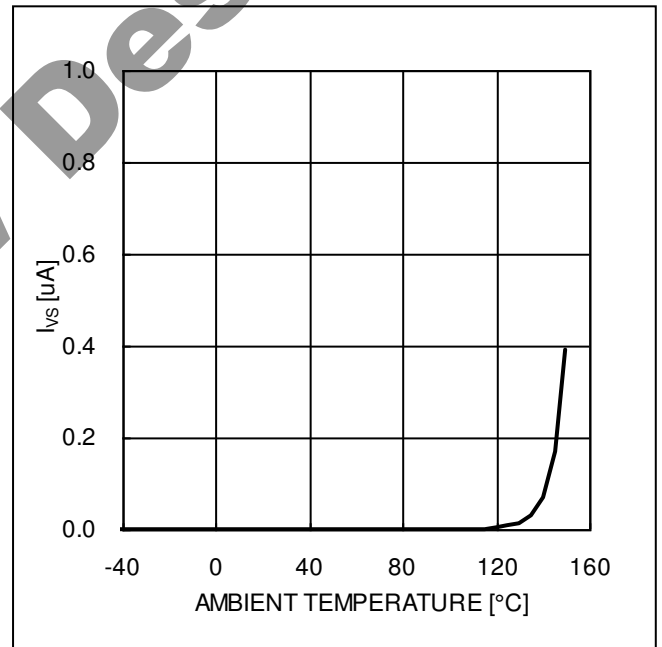

Figure 7. Offset Supply Leakage Current - T_a
($V_B=V_S=600\text{V}$)

Typical Performance Curves

(Unless otherwise specified: $T_a=25^{\circ}\text{C}$, $V_{CC}=15\text{V}$, $V_{BS}=15\text{V}$, $V_S=\text{COM}$, $C_L=1000\text{pF}$)

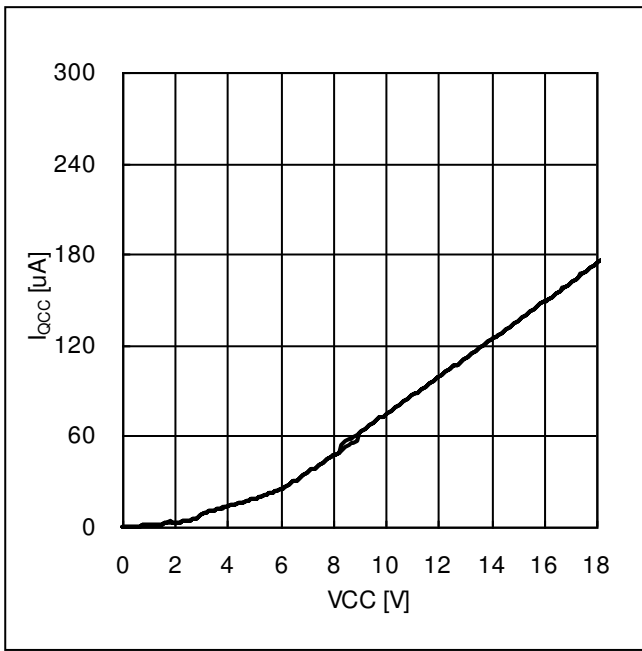

Figure 8. Quiescent V_{CC} Supply Current - V_{CC}

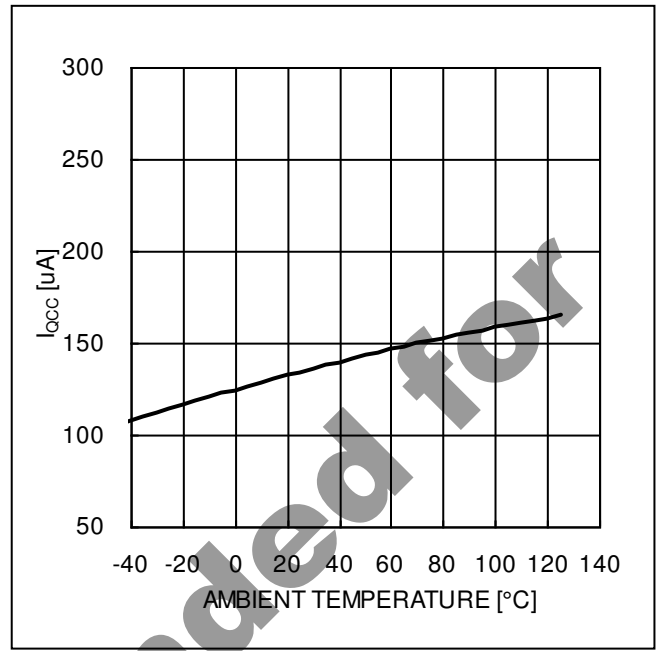

Figure 9. Quiescent V_{CC} Supply Current - T_a ($V_{CC}=15\text{V}$)

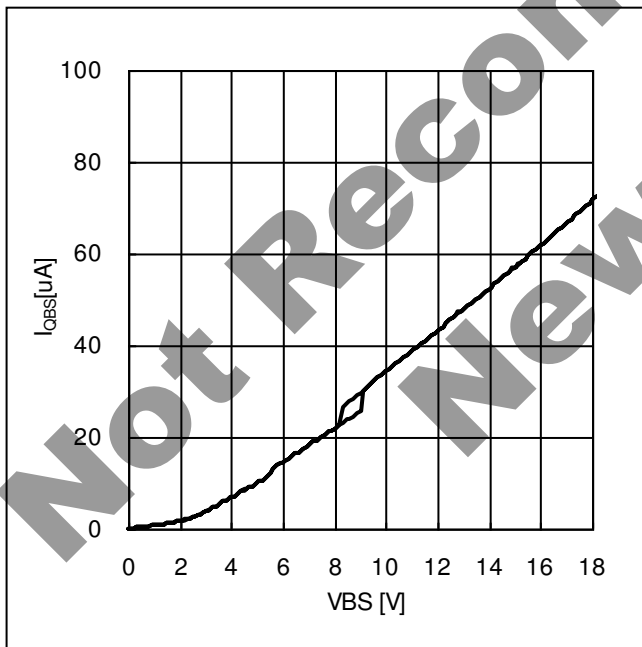

Figure 10. Quiescent V_{BS} Supply Current - V_{BS}

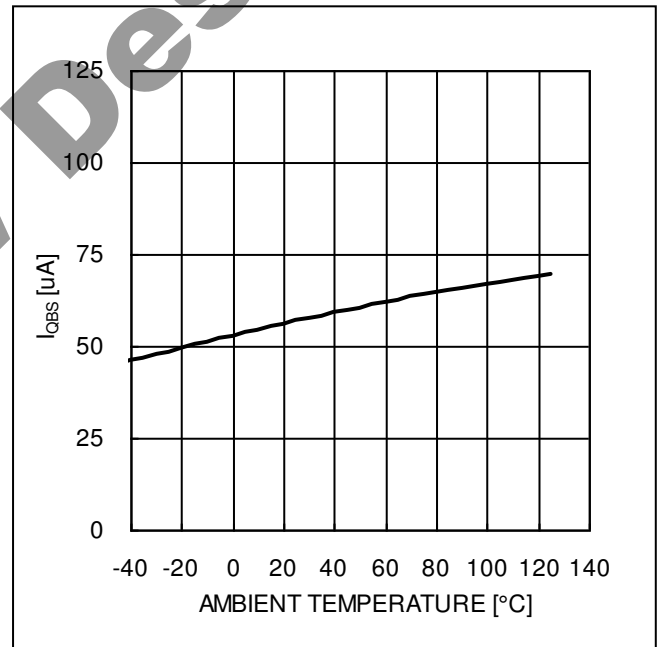

Figure 11. Quiescent V_{BS} Supply Current - T_a ($V_{BS}=15\text{V}$)

Typical Performance Curves

(Unless otherwise specified: $T_a=25^\circ\text{C}$, $V_{CC}=15\text{V}$, $V_{BS}=15\text{V}$, $V_S=\text{COM}$, $C_L=1000\text{pF}$)

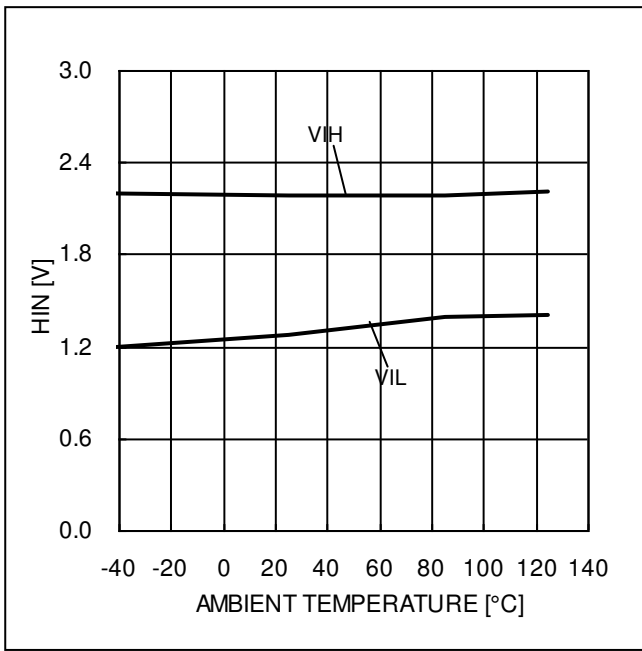

Figure 12. HIN Input Threshold Voltage - Ta

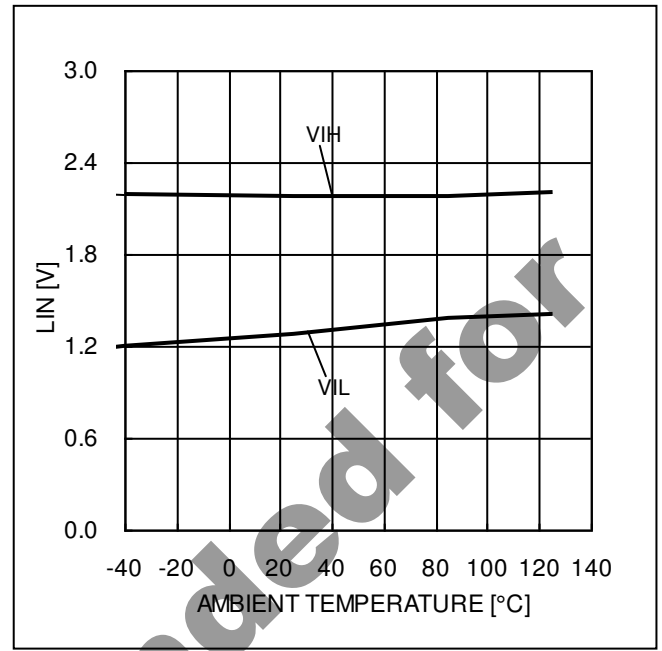

Figure 13. LIN Input Threshold Voltage - Ta

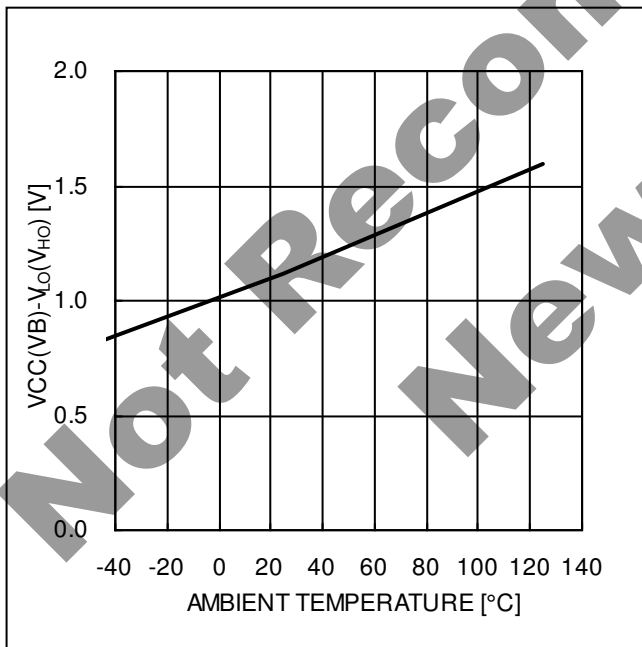

Figure 14. High Level Output Voltage - Ta
($I_o=20\text{mA}$)

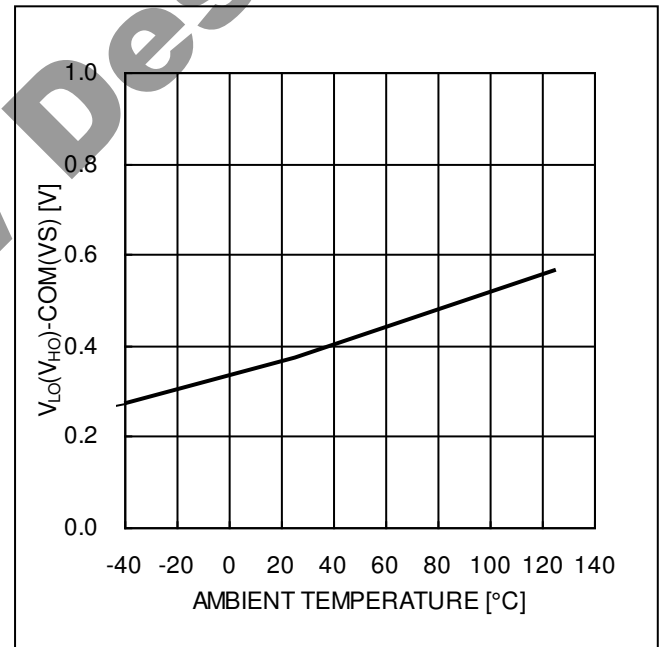

Figure 15. Low Level Output Voltage - Ta
($I_o=20\text{mA}$)

Typical Performance Curves

(Unless otherwise specified: $T_a=25^\circ\text{C}$, $V_{CC}=15\text{V}$, $V_{BS}=15\text{V}$, $V_S=\text{COM}$, $C_L=1000\text{pF}$)

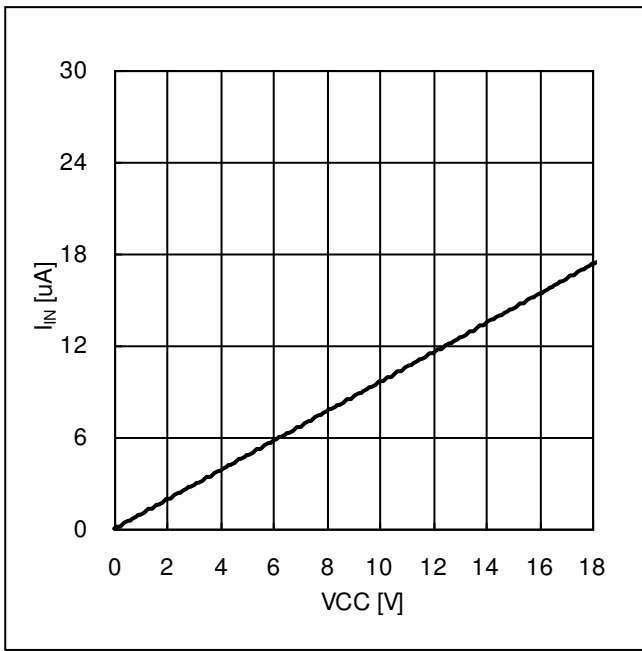

Figure 16. Input Bias Current - VIN

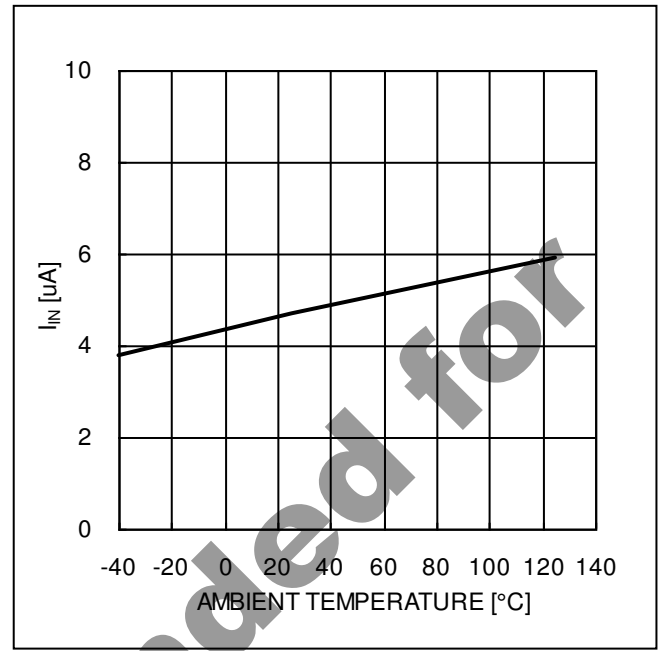

Figure 17. Input Bias Current - Ta (VIN=5V)

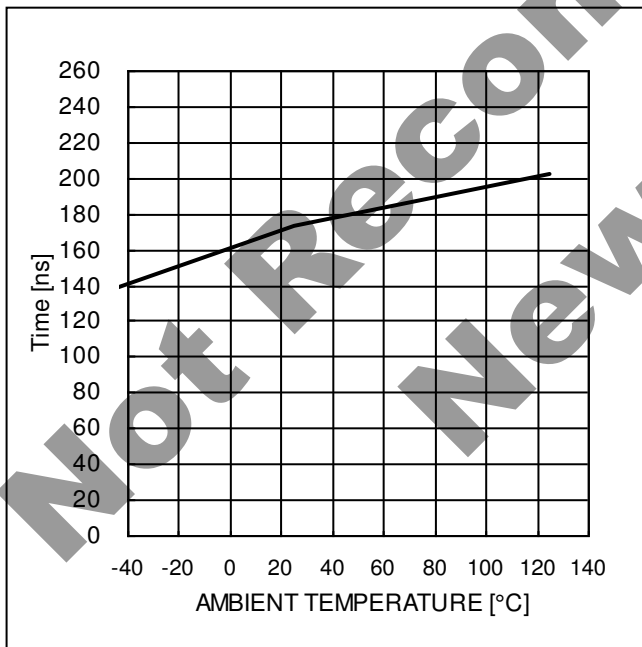

Figure 18. Dead time - Ta (LO off - HO on)

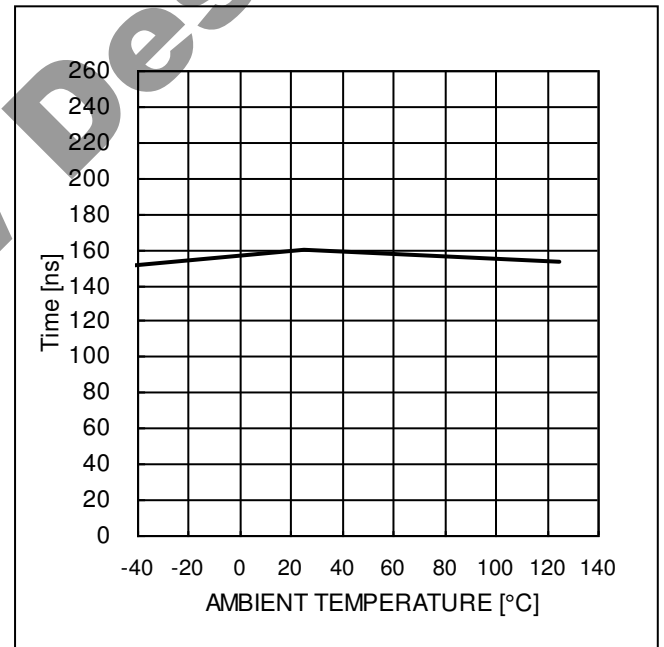

Figure 19. Dead time - Ta (HO off - LO on)

Typical Performance Curves

(Unless otherwise specified: $T_a=25^\circ\text{C}$, $V_{CC}=15\text{V}$, $V_{BS}=15\text{V}$, $V_S=\text{COM}$, $C_L=1000\text{pF}$)

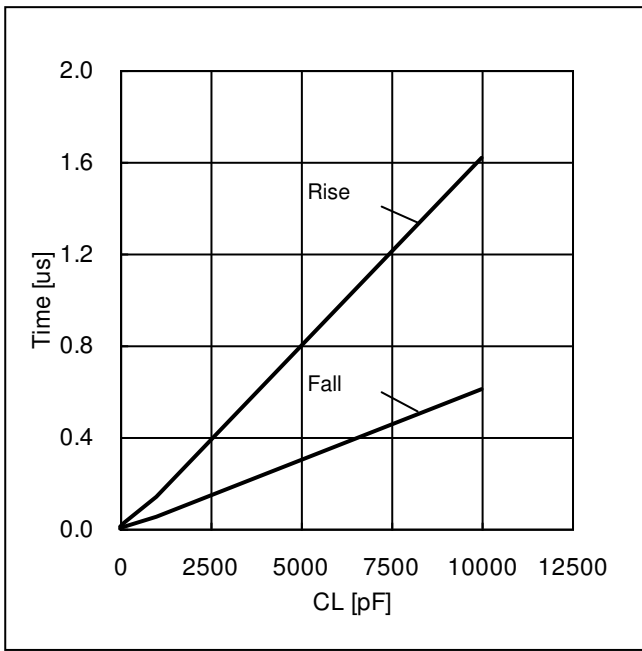

Figure 20. LO Rise/Fall time – Load Capacitance

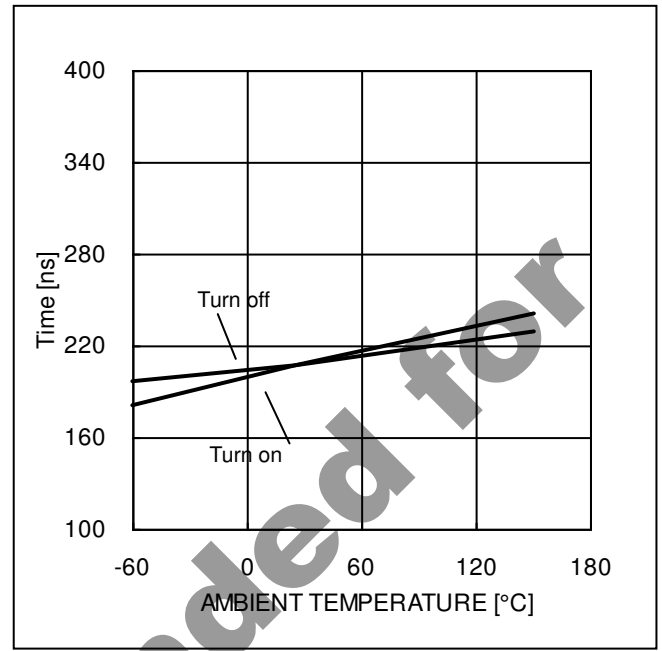

Figure 21. LO Turn on/off Propagation Delay - T_a

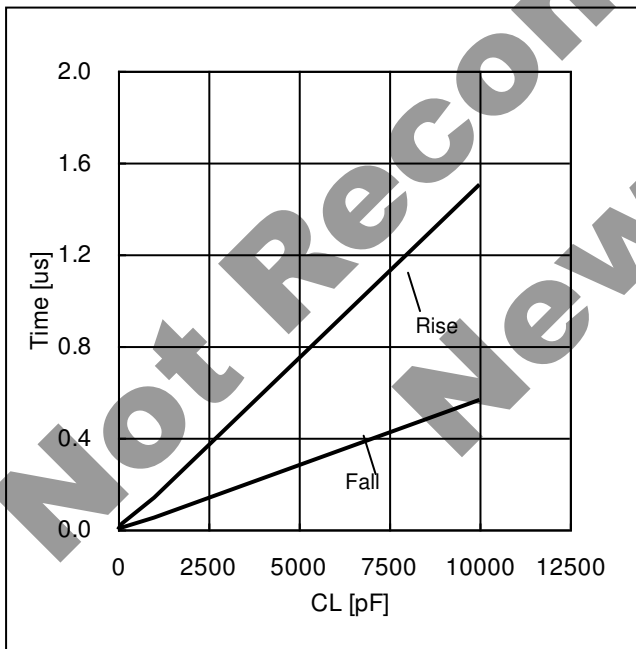

Figure 22. HO Rise/Fall time – Load Capacitance

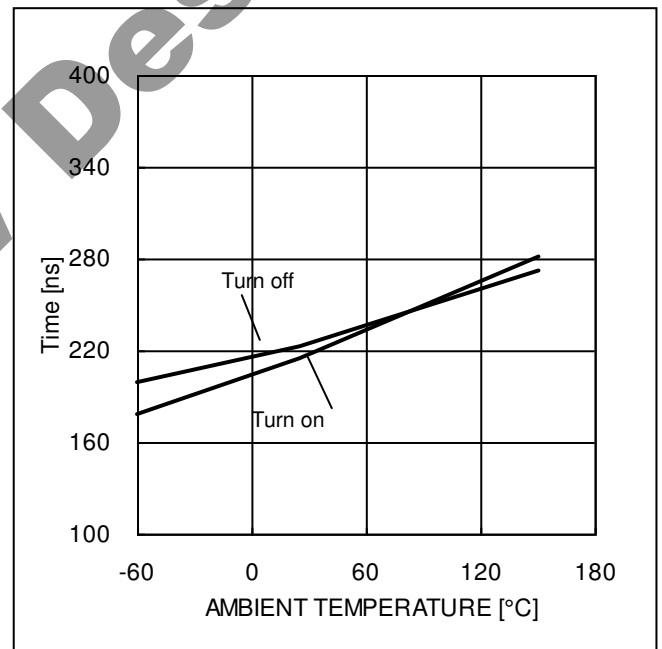

Figure 23. HO Turn on/off Propagation Delay - T_a

Timing Chart

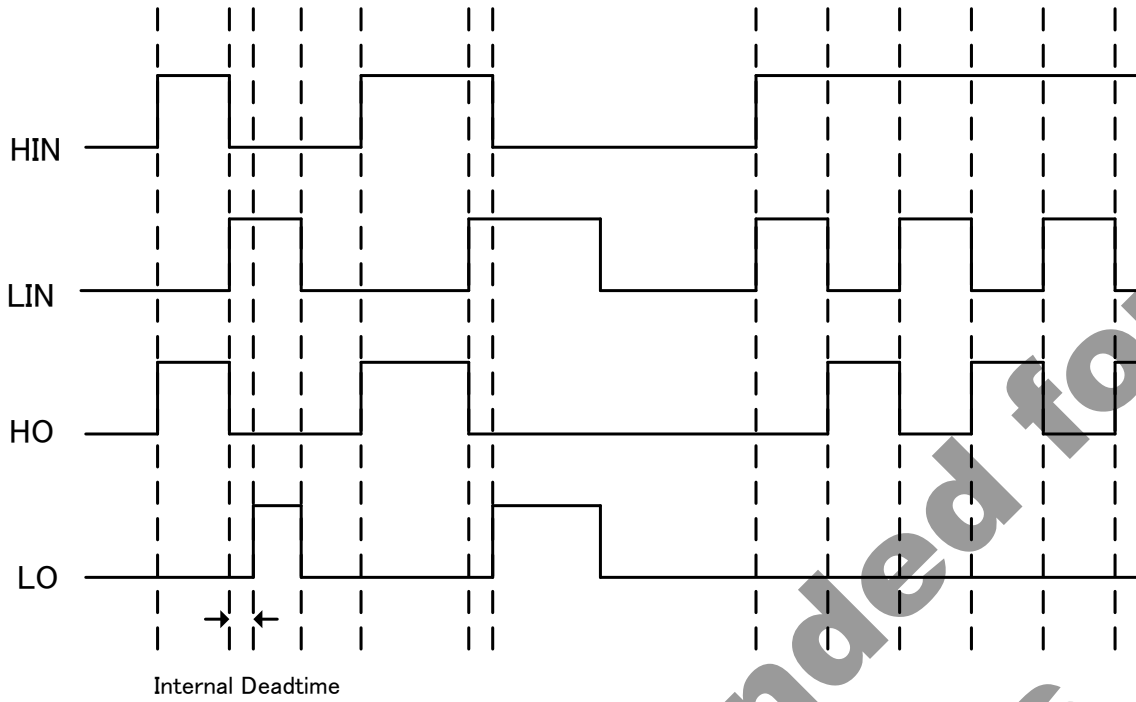

Figure 24. Timing Chart

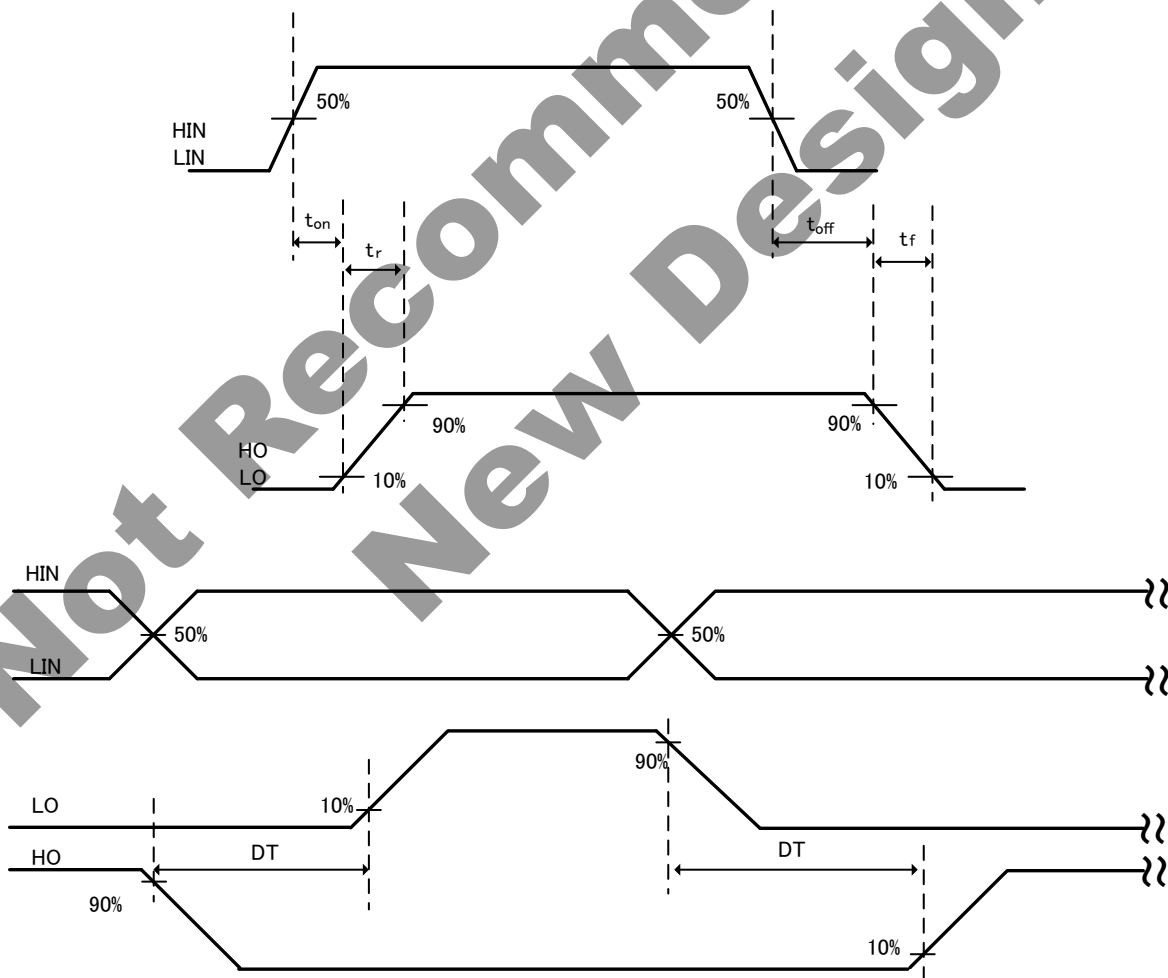

Figure 25. Detail Timing Chart

Power Dissipation

It is shown below reducing characteristics of power dissipation to mount 70mm × 70mm × 1.6mm^t, 1layer PCB.
 Junction temperature must be designed not to exceed 150°C

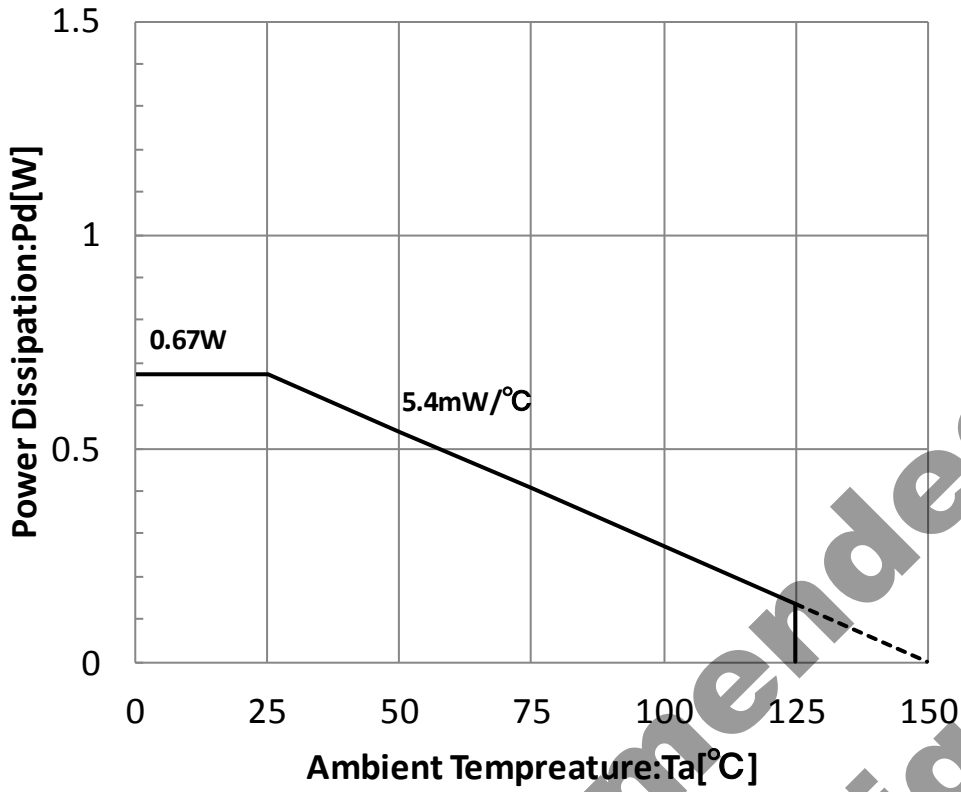

Figure 26. Power Dissipation(70mm × 70mm × 1.6mm^t 1layer PCB)

Not Recommended for New Designs

I/O Equivalence Circuits

| Pin.No | Pin Name | Pin Equivalent Circuit | Pin.No | Pin Name | Pin Equivalent Circuit |
|--------|----------|------------------------|--------|----------|------------------------|
| 1 | LIN | | 2 | HIN | |
| 5 | LO | | 7 | HO | |

Figure 27. I/O Equivalent Circuit

Not Recommended for New Designs

Operational Notes**1. Reverse Connection of Power Supply**

Connecting the power supply in reverse polarity can damage the IC. Take precautions against reverse polarity when connecting the power supply, such as mounting an external diode between the power supply and the IC's power supply pins.

2. Power Supply Lines

Design the PCB layout pattern to provide low impedance supply lines. Furthermore, connect a capacitor to ground at all power supply pins. Consider the effect of temperature and aging on the capacitance value when using electrolytic capacitors.

3. Ground Voltage

Ensure that no pins are at a voltage below that of the ground pin at any time, even during transient condition.

4. Ground Wiring Pattern

When using both small-signal and large-current ground traces, the two ground traces should be routed separately but connected to a single ground at the reference point of the application board to avoid fluctuations in the small-signal ground caused by large currents. Also ensure that the ground traces of external components do not cause variations on the ground voltage. The ground lines must be as short and thick as possible to reduce line impedance.

5. Thermal Consideration

Should by any chance the power dissipation rating be exceeded the rise in temperature of the chip may result in deterioration of the properties of the chip. In case of exceeding this absolute maximum rating, increase the board size and copper area to prevent exceeding the Pd rating.

6. Recommended Operating Conditions

These conditions represent a range within which the expected characteristics of the IC can be approximately obtained. The electrical characteristics are guaranteed under the conditions of each parameter.

7. Inrush Current

When power is first supplied to the IC, it is possible that the internal logic may be unstable and inrush current may flow instantaneously due to the internal powering sequence and delays, especially if the IC has more than one power supply. Therefore, give special consideration to power coupling capacitance, power wiring, width of ground wiring, and routing of connections.

8. Operation Under Strong Electromagnetic Field

Operating the IC in the presence of a strong electromagnetic field may cause the IC to malfunction.

9. Testing on Application Boards

When testing the IC on an application board, connecting a capacitor directly to a low-impedance output pin may subject the IC to stress. Always discharge capacitors completely after each process or step. The IC's power supply should always be turned off completely before connecting or removing it from the test setup during the inspection process. To prevent damage from static discharge, ground the IC during assembly and use similar precautions during transport and storage.

10. Inter-pin Short and Mounting Errors

Ensure that the direction and position are correct when mounting the IC on the PCB. Incorrect mounting may result in damaging the IC. Avoid nearby pins being shorted to each other especially to ground, power supply and output pin. Inter-pin shorts could be due to many reasons such as metal particles, water droplets (in very humid environment) and unintentional solder bridge deposited in between pins during assembly to name a few.

11. Unused Input Pins

Input pins of an IC are often connected to the gate of a MOS transistor. The gate has extremely high impedance and extremely low capacitance. If left unconnected, the electric field from the outside can easily charge it. The small charge acquired in this way is enough to produce a significant effect on the conduction through the transistor and cause unexpected operation of the IC. So unless otherwise specified, unused input pins should be connected to the power supply or ground line.

12. Ceramic Capacitor

When using a ceramic capacitor, determine the dielectric constant considering the change of capacitance with temperature and the decrease in nominal capacitance due to DC bias and others.

13. Area of Safe Operation (ASO)

Operate the IC such that the output voltage, output current, and power dissipation are all within the Area of Safe Operation (ASO).

Ordering Information

B S 2 1 0 0 F

E 2

Part Number

Package
F:SOP-8

Packaging and forming specification
E2: Embossed tape and reel

Marking Diagrams

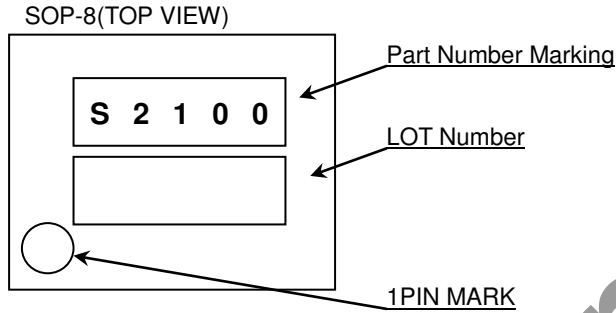

Not Recommended for New Designs

Physical Dimension, Tape and Reel Information

| | |
|--------------|------|
| Package Name | SOP8 |
|--------------|------|

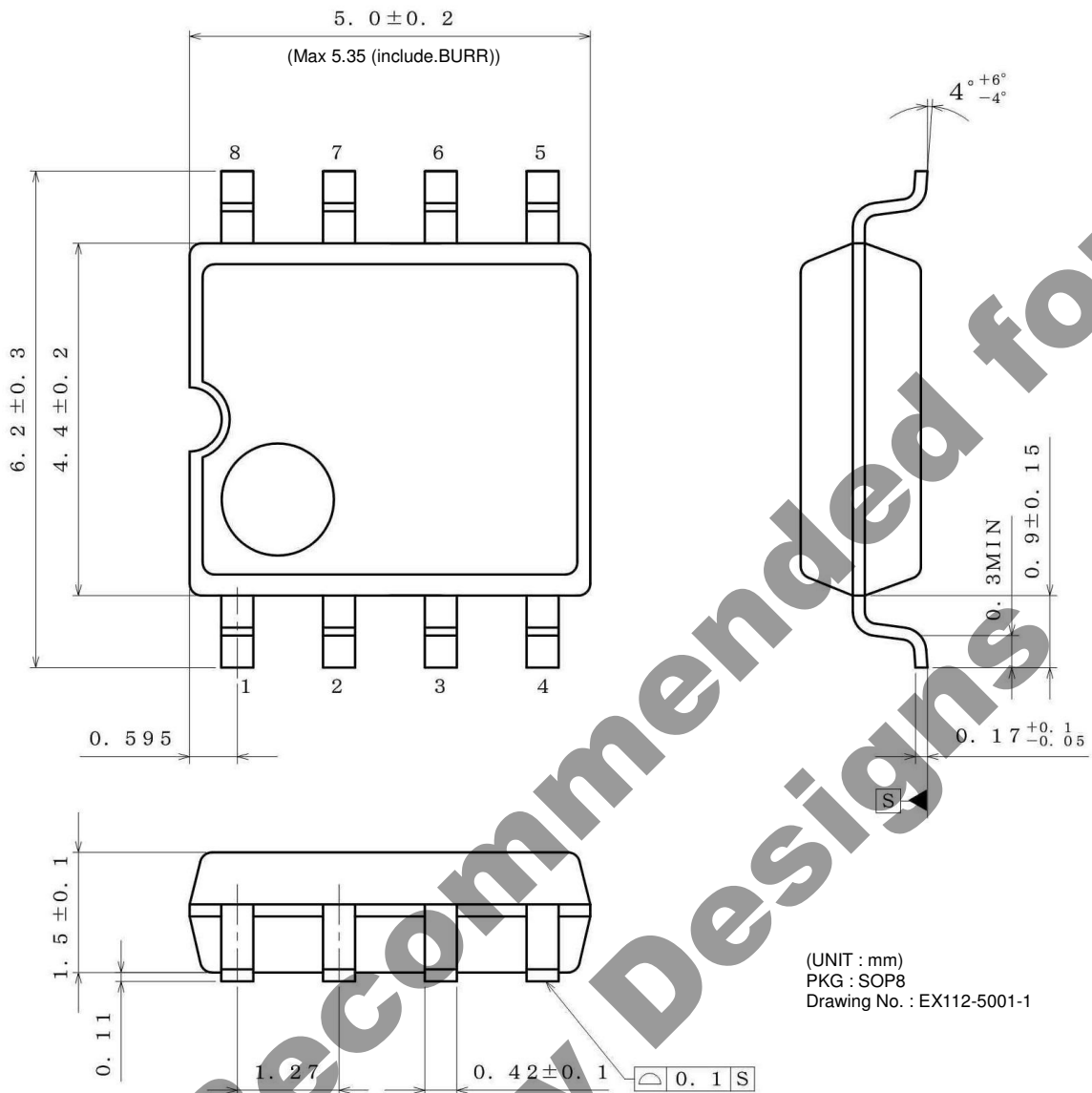

<Tape and Reel information>

| | |
|-------------------|---|
| Tape | Embossed carrier tape |
| Quantity | 2500pcs |
| Direction of feed | E2 (The direction is the 1pin of product is at the upper left when you hold reel on the left hand and you pull out the tape on the right hand) |

Reel 1pin Direction of feed

*Order quantity needs to be multiple of the minimum quantity.

Revision History

| Date | Revision | Changes |
|------------|----------|---|
| 1.NOV.2014 | 001 | New Release |
| 2.FEB.2015 | 002 | Correction of Typographical Error.(P.1 & P.8) |

**Not Recommended for
New Designs**

Notice

Precaution on using ROHM Products

- Our Products are designed and manufactured for application in ordinary electronic equipments (such as AV equipment, OA equipment, telecommunication equipment, home electronic appliances, amusement equipment, etc.). If you intend to use our Products in devices requiring extremely high reliability (such as medical equipment ^(Note 1), transport equipment, traffic equipment, aircraft/spacecraft, nuclear power controllers, fuel controllers, car equipment including car accessories, safety devices, etc.) and whose malfunction or failure may cause loss of human life, bodily injury or serious damage to property ("Specific Applications"), please consult with the ROHM sales representative in advance. Unless otherwise agreed in writing by ROHM in advance, ROHM shall not be in any way responsible or liable for any damages, expenses or losses incurred by you or third parties arising from the use of any ROHM's Products for Specific Applications.

(Note1) Medical Equipment Classification of the Specific Applications

| JAPAN | USA | EU | CHINA |
|-----------|-----------|------------|-----------|
| CLASS III | CLASS III | CLASS II b | CLASS III |
| CLASS IV | | CLASS III | |

- ROHM designs and manufactures its Products subject to strict quality control system. However, semiconductor products can fail or malfunction at a certain rate. Please be sure to implement, at your own responsibilities, adequate safety measures including but not limited to fail-safe design against the physical injury, damage to any property, which a failure or malfunction of our Products may cause. The following are examples of safety measures:
 - Installation of protection circuits or other protective devices to improve system safety
 - Installation of redundant circuits to reduce the impact of single or multiple circuit failure
- Our Products are designed and manufactured for use under standard conditions and not under any special or extraordinary environments or conditions, as exemplified below. Accordingly, ROHM shall not be in any way responsible or liable for any damages, expenses or losses arising from the use of any ROHM's Products under any special or extraordinary environments or conditions. If you intend to use our Products under any special or extraordinary environments or conditions (as exemplified below), your independent verification and confirmation of product performance, reliability, etc. prior to use, must be necessary:
 - Use of our Products in any types of liquid, including water, oils, chemicals, and organic solvents
 - Use of our Products outdoors or in places where the Products are exposed to direct sunlight or dust
 - Use of our Products in places where the Products are exposed to sea wind or corrosive gases, including Cl₂, H₂S, NH₃, SO₂, and NO₂
 - Use of our Products in places where the Products are exposed to static electricity or electromagnetic waves
 - Use of our Products in proximity to heat-producing components, plastic cords, or other flammable items
 - Sealing or coating our Products with resin or other coating materials
 - Use of our Products without cleaning residue of flux (even if you use no-clean type fluxes, cleaning residue of flux is recommended); or Washing our Products by using water or water-soluble cleaning agents for cleaning residue after soldering
 - Use of the Products in places subject to dew condensation
- The Products are not subject to radiation-proof design.
- Please verify and confirm characteristics of the final or mounted products in using the Products.
- In particular, if a transient load (a large amount of load applied in a short period of time, such as pulse. is applied, confirmation of performance characteristics after on-board mounting is strongly recommended. Avoid applying power exceeding normal rated power; exceeding the power rating under steady-state loading condition may negatively affect product performance and reliability.
- De-rate Power Dissipation (Pd) depending on Ambient temperature (Ta). When used in sealed area, confirm the actual ambient temperature.
- Confirm that operation temperature is within the specified range described in the product specification.
- ROHM shall not be in any way responsible or liable for failure induced under deviant condition from what is defined in this document.

Precaution for Mounting / Circuit board design

- When a highly active halogenous (chlorine, bromine, etc.) flux is used, the residue of flux may negatively affect product performance and reliability.
- In principle, the reflow soldering method must be used on a surface-mount products, the flow soldering method must be used on a through hole mount products. If the flow soldering method is preferred on a surface-mount products, please consult with the ROHM representative in advance.

For details, please refer to ROHM Mounting specification

Precautions Regarding Application Examples and External Circuits

1. If change is made to the constant of an external circuit, please allow a sufficient margin considering variations of the characteristics of the Products and external components, including transient characteristics, as well as static characteristics.
2. You agree that application notes, reference designs, and associated data and information contained in this document are presented only as guidance for Products use. Therefore, in case you use such information, you are solely responsible for it and you must exercise your own independent verification and judgment in the use of such information contained in this document. ROHM shall not be in any way responsible or liable for any damages, expenses or losses incurred by you or third parties arising from the use of such information.

Precaution for Electrostatic

This Product is electrostatic sensitive product, which may be damaged due to electrostatic discharge. Please take proper caution in your manufacturing process and storage so that voltage exceeding the Products maximum rating will not be applied to Products. Please take special care under dry condition (e.g. Grounding of human body / equipment / solder iron, isolation from charged objects, setting of Ionizer, friction prevention and temperature / humidity control).

Precaution for Storage / Transportation

1. Product performance and soldered connections may deteriorate if the Products are stored in the places where:
 - [a] the Products are exposed to sea winds or corrosive gases, including Cl₂, H₂S, NH₃, SO₂, and NO₂
 - [b] the temperature or humidity exceeds those recommended by ROHM
 - [c] the Products are exposed to direct sunshine or condensation
 - [d] the Products are exposed to high Electrostatic
2. Even under ROHM recommended storage condition, solderability of products out of recommended storage time period may be degraded. It is strongly recommended to confirm solderability before using Products of which storage time is exceeding the recommended storage time period.
3. Store / transport cartons in the correct direction, which is indicated on a carton with a symbol. Otherwise bent leads may occur due to excessive stress applied when dropping of a carton.
4. Use Products within the specified time after opening a humidity barrier bag. Baking is required before using Products of which storage time is exceeding the recommended storage time period.

Precaution for Product Label

QR code printed on ROHM Products label is for ROHM's internal use only.

Precaution for Disposition

When disposing Products please dispose them properly using an authorized industry waste company.

Precaution for Foreign Exchange and Foreign Trade act

Since our Products might fall under controlled goods prescribed by the applicable foreign exchange and foreign trade act, please consult with ROHM representative in case of export.

Precaution Regarding Intellectual Property Rights

1. All information and data including but not limited to application example contained in this document is for reference only. ROHM does not warrant that foregoing information or data will not infringe any intellectual property rights or any other rights of any third party regarding such information or data. ROHM shall not be in any way responsible or liable for infringement of any intellectual property rights or other damages arising from use of such information or data.:
2. No license, expressly or implied, is granted hereby under any intellectual property rights or other rights of ROHM or any third parties with respect to the information contained in this document.

Other Precaution

1. This document may not be reprinted or reproduced, in whole or in part, without prior written consent of ROHM.
2. The Products may not be disassembled, converted, modified, reproduced or otherwise changed without prior written consent of ROHM.
3. In no event shall you use in any way whatsoever the Products and the related technical information contained in the Products or this document for any military purposes, including but not limited to, the development of mass-destruction weapons.
4. The proper names of companies or products described in this document are trademarks or registered trademarks of ROHM, its affiliated companies or third parties.

General Precaution

1. Before you use our Products, you are requested to carefully read this document and fully understand its contents. ROHM shall not be in any way responsible or liable for failure, malfunction or accident arising from the use of any ROHM's Products against warning, caution or note contained in this document.
2. All information contained in this document is current as of the issuing date and subject to change without any prior notice. Before purchasing or using ROHM's Products, please confirm the latest information with a ROHM sales representative.
3. The information contained in this document is provided on an "as is" basis and ROHM does not warrant that all information contained in this document is accurate and/or error-free. ROHM shall not be in any way responsible or liable for any damages, expenses or losses incurred by you or third parties resulting from inaccuracy or errors of or concerning such information.

**Not Recommended for
New Designs**