

Excellent Integrated System Limited

Stocking Distributor

Click to view price, real time Inventory, Delivery & Lifecycle Information:

[Recom Power](#)
[RP20-4805SAW](#)

For any questions, you can email us directly:

sales@integrated-circuit.com

Features

Regulated Converters

- Wide 4:1 Input Voltage Range
- 1.6kVDC Isolation
- UL Certified
- Efficiency up to 90%
- Six-Sided Continuous Shield
- No Minimum Load



RP20-AW

20 Watt Single & Dual Output



Description

The RP20-AW series are ultraminiature wide input voltage range power DC/DC converters in a case half the size of industry standard 20W converters. Despite their small size, the RP20-AW converters are fully specified devices with output currents up to 4.5 Amps, up to 90% efficiency, no minimum load, 1600VDC isolation, a built-in Class A EMC filter and low ripple/noise figures. The outputs are also fully protected against short circuits, overcurrent and overvoltage. The no load input current is particularly low (only 4mA/6mA). The RP20-AW series will find many uses in applications where board space and/or board height is at a premium or in battery-powered systems where standby current is important.

Selection Guide

Part Number	Input Voltage Range [VDC]	Output Voltage [VDC]	Output Current [mA]	Input ⁽¹⁾ Current [mA]	Efficiency ⁽¹⁾ typ. [%]	Max. Capacitive Load ⁽²⁾ [µF]
RP20-243.3SAW ^(3,4)	9-36	3.3	4500	695	89	7000
RP20-2405SAW ^(3,4)	9-36	5	4000	936	89	5000
RP20-2412SAW ^(3,4)	9-36	12	1670	938	89	850
RP20-2415SAW ^(3,4)	9-36	15	1330	934	89	700
RP20-483.3SAW ^(3,4)	18-75	3.3	4500	356	87	7000
RP20-4805SAW ^(3,4)	18-75	5	4000	468	89	5000
RP20-4812SAW ^(3,4)	18-75	12	1670	469	89	850
RP20-4815SAW ^(3,4)	18-75	15	1330	462	90	700
RP20-2412DAW ^(3,4)	9-36	±12	±833	936	89	±500
RP20-2415DAW ^(3,4)	9-36	±15	±667	926	90	±350
RP20-4812DAW ^(3,4)	18-75	±12	±833	468	89	±500
RP20-4815DAW ^(3,4)	18-75	±15	±667	463	90	±350



Notes:

- Note1: Values at nominal input voltage and no load/full load
 Note2: Test by minimum Vin and constant resistor load.



Model Numbering

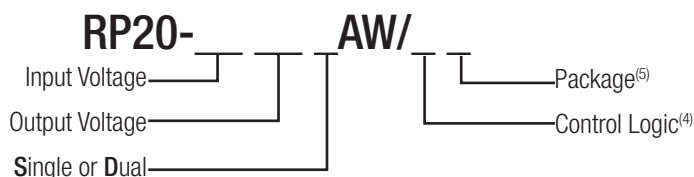

Ordering Examples

- RP20-2405SAW/P = 24V 4:1 Input, 5V Output, Positive Logic CTRL pin and Trim pin fitted.
 RP20-483.3SAW-HC = 48V 4:1 Input, 3.3V Output, Premounted Heat-sink, no Trim or CTRL pins.
 (no trim pin available with dual output)

Notes:

- Note3: no suffix is standard part without trim pin and CTRL function fitted.
 add suffix "P" for CTRL function with positive logic (1=ON, 0=OFF), including trim pin
 add suffix "N" for CTRL function with negative logic (0=ON, 1=OFF), including trim pin
 Note4: add suffix -HC for premounted Heat-sink and clips

UL60950-1 Certified

RECOM

DC/DC Converter

RP20-AW Series

Specifications measured at Ta = 25°C, nominal input voltage, full load otherwise noted

BASIC CHARACTERISTICS					
Parameter	Condition		Min.	Typ.	Max.
Input Voltage Range	nom. Vin = 24V nom. Vin = 48V		9VDC 18VDC	24VDC 48VDC	36VDC 75VDC
Under Voltage Lockout (UVLO)	Vin = 24V	DC-DC ON DC-DC OFF		8VDC	9VDC
	Vin = 48V	DC-DC ON DC-DC OFF		16VDC	18VDC
Input Filter					Pi-Type
Input Reflected Ripple Current ⁽⁵⁾	nominal Vin and full load			30mA _{p-p}	
Input Surge Voltage	Vin = 24V, 100ms max. Vin = 48V, 100ms max.				50VDC 100VDC
Start-up time	Power up				30ms
	Remote ON/OFF				30ms
Operating Frequency Range	3.3V _{out} , 5V _{out}		248kHz 297kHz	275kHz 330kHz	303kHz 363kHz
	Others				
Minimum Load			0%		
Optional Output Trim ⁽⁶⁾					±10%
Ripple and Noise	measured by 20Mhz bandwidth with 1µF M/C X7R and a 10µF T/C	Single		75mV _{p-p}	
	measured by 20Mhz bandwidth with 1µF M/C X7R and 10µF T/C for each output	Dual		100mV _{p-p}	
Remote ON/OFF ⁽⁶⁾	Positive Logic	DC-DC ON DC-DC OFF	Open or 3.0V < Vr < 15V Short or 0V < Vr < 1.2V		
	Negative Logic	DC-DC ON DC-DC OFF	Short or 0V < Vr < 1.2V Open or 3.0V < Vr < 15V		
Input current of Remote pin (CTRL)				2mA	
			DC-DC ON	-0.5mA	1mA

Notes:

Note5: Simulated source impedance of 12µH. 12µH inductor in series with +Vin.

Note6: The ON/OFF control function can be positive or negative logic. The pin voltage is referenced to -Vin pin. If no suffix is specified, the control pin will be omitted.

RP20-2405SAW

Efficiency vs. Output Current

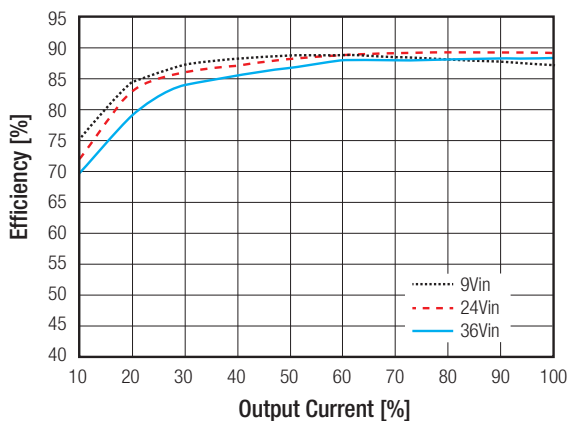

Efficiency vs. Input Voltage

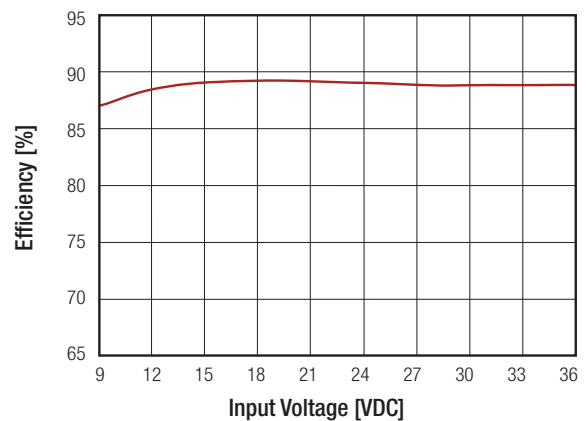

RECOM

DC/DC Converter

RP20-AW Series

Specifications measured at Ta = 25°C, nominal input voltage, full load otherwise noted

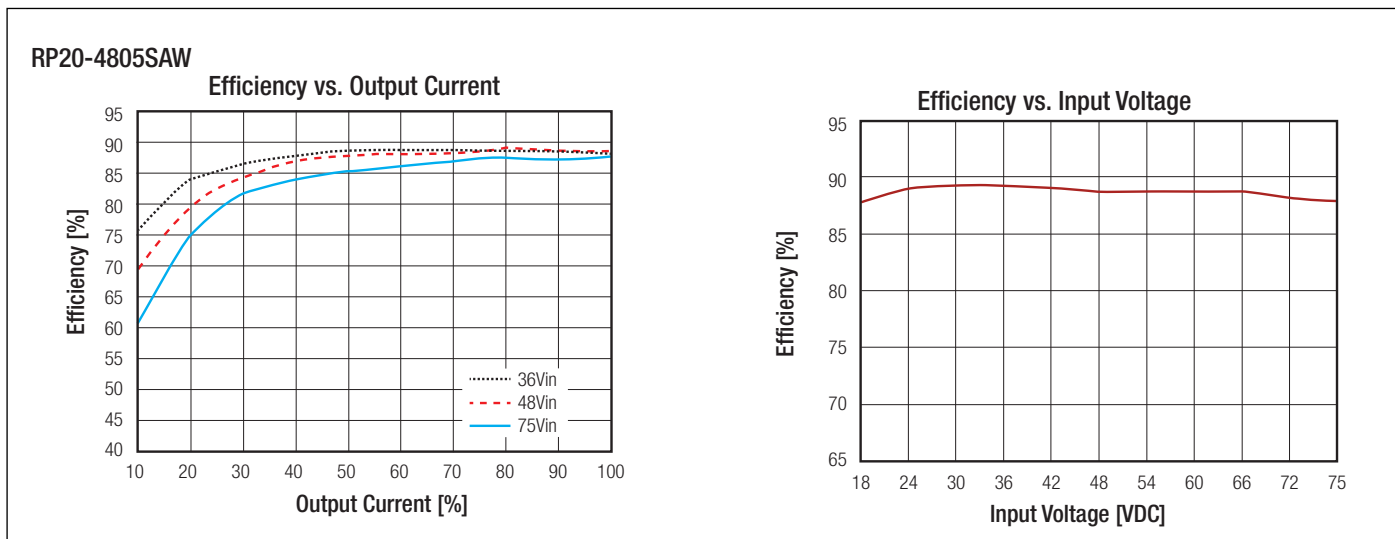

REGULATIONS		
Parameter	Condition	Value
Output Voltage Accuracy		±1%
Voltage Adjustability	Single	±10%
Line Voltage Regulation	Single	±0.2%
	Dual	±0.5%
Load Voltage Regulation	0% load to 100% load	±0.2%
		±1.0%
	10% load to 100% load	±0.1%
		±0.8%
Cross Regulation	asymmetrical 25% <-> 100% load	±5%
Transient Response recovery time	25% load step change	250µs typ.

External Output Trimming

Output Voltage Trimming

Single output Powerline converters offer the feature of trimming the output voltage over a certain range around the nominal value by using external trim resistors. No general equation can be given for calculating the trim resistors, but the following trimtables give typical values for choosing these trimming resistors. If voltages between the given trim points are required, extrapolate between the two nearest given values to work out the resistor required or use a variable resistor to set the output voltage. Output can be externally trimmed by using the method shown below.

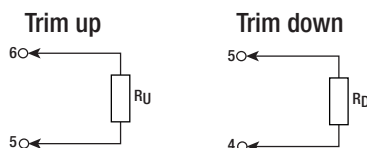

RP20-xx3.3SAW

Trim up	1	2	3	4	5	6	7	8	9	10	%
V _{out} =	3.333	3.366	3.399	3.432	3.465	3.498	3.531	3.564	3.597	3.63	Volts
R _U =	57.93	26.16	15.58	10.28	7.11	4.99	3.48	2.34	1.46	0.75	KOhms
Trim down	1	2	3	4	5	6	7	8	9	10	%
V _{out} =	3.267	3.234	3.201	3.168	3.135	3.102	3.069	3.036	3.003	2.97	Volts
R _D =	69.47	31.23	18.49	12.12	8.29	5.74	3.92	2.56	1.50	0.65	KOhms

continued on next page

Specifications measured at Ta = 25°C, nominal input voltage, full load otherwise noted

RP20-xx05SAW											
Trim up	1	2	3	4	5	6	7	8	9	10	%
Vout =	5.05	5.10	5.15	5.20	5.25	5.30	5.35	5.4	5.45	5.50	Volts
R _u =	36.57	16.58	9.92	6.58	4.59	3.25	2.30	1.59	1.03	0.59	KOhms
Trim down	1	2	3	4	5	6	7	8	9	10	%
Vout =	4.95	4.90	4.85	4.80	4.75	4.70	4.65	4.60	4.55	4.50	Volts
R _o =	45.53	20.61	12.31	8.15	5.66	4.00	2.81	1.92	1.23	0.68	KOhms
RP20-xx12SAW											
Trim up	1	2	3	4	5	6	7	8	9	10	%
Vout =	12.12	12.24	12.36	12.48	12.60	12.72	12.84	12.96	13.08	13.20	Volts
R _u =	367.91	165.95	98.64	64.98	44.78	31.32	21.70	14.49	8.88	4.39	KOhms
Trim down	1	2	3	4	5	6	7	8	9	10	%
Vout =	11.88	11.76	11.64	11.52	11.40	11.28	11.16	11.04	10.92	10.8	Volts
R _o =	460.99	207.95	123.60	81.42	56.12	39.25	27.20	18.16	11.13	5.51	KOhms
RP20-xx15SAW											
Trim up	1	2	3	4	5	6	7	8	9	10	%
Vout =	15.15	15.3	15.45	15.60	15.75	15.90	16.05	16.20	16.35	16.50	Volts
R _u =	404.18	180.59	106.06	68.80	46.44	31.53	20.88	12.90	6.69	1.72	KOhms
Trim down	1	2	3	4	5	6	7	8	9	10	%
Vout =	14.85	14.70	14.55	14.40	14.25	14.10	13.95	13.80	13.65	13.50	Volts
R _o =	499.82	223.41	131.27	85.20	57.56	39.14	25.97	16.10	8.42	2.282	KOhms

PROTECTIONS		
Parameter	Condition	Value
Short Circuit Protection (SCP)		continuous, automatic recovery
Over Voltage Protection (OVP)	Zener Diode Clamp	3.3Vout 5Vout 12Vout 15Vout 3.7VDC - 5.4VDC 5.6VDC - 7.0VDC 13.5VDC - 19.6VDC 16.8VDC - 20.5VDC
Over Load Protection (OLP)	% of lout rated; Hiccup mode	150% typ
Isolation Voltage	I/P to O/P I/P to O/P to case	1.6kVDC/1 minute 1.0kVDC/1 minute
Isolation Resistance	500 VDC	1GΩ min
Isolation Capacitance		1500pF max.

Notes:

Note7: This power module is not internally fused. An input line fuse must always be used.

RECOM

DC/DC Converter

RP20-AW Series

Specifications measured at Ta = 25°C, nominal input voltage, full load otherwise noted

ENVIRONMENTAL		
Parameter	Condition	Value
Operating Temperature Range	without derating	-40°C to +68°C
	with derating	-40°C to +101°C
Maximum Case Temperature		+105°C
Temperature Coefficient		±0.02%/°C max.
Thermal Impedance	Natural convection	17.6°C/Watt
	Natural convection with Heat Sink	14.8°C/Watt
Operating Humidity		5% - 95% RH
Thermal Shock		MIL-STD-810F
Vibration		MIL-STD-810F
MTBF ⁽⁸⁾	Bellcore TR-NWT-000332	1766 x 10 ³ hours
	MIL-HDBK-217F	1469 x 10 ³ hours

Derating Graph⁽⁹⁾

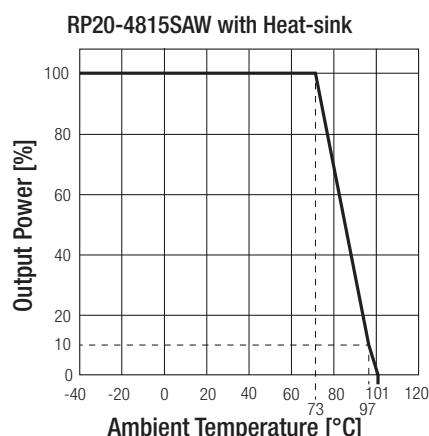
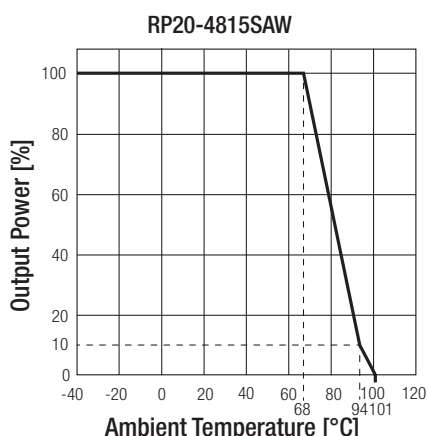

Notes:

- Note8: BELLCORE TR-NWT-000332. Case I: 50% Stress, Temperature at 40°C.
 MIL-HDBK 217F Notice 2. Ta = 25°C, full load, (Ground, Benign, controlled environment).
- Note9: Derating graphs are valid only for the shown part numbers. If you need detailed derating-information about a part-number not shown here please contact our technical support service at techsupportAT@recom-power.com.

SAFETY AND CERTIFICATIONS

Certificate Type (Safety)	Condition	Standard
UL General Safety	E196683	UL60950-1 1st Ed.: 2003 C22.2 No. 60950 1st. Ed.: 2003
EMC Compliance	Condition	Standard / Criterion
EMI Standard ⁽¹⁰⁾	with external filter	EN55022, Class A or B
ESD	Air ±8kV and Contact ±6kC	EN61000-4-2, Criteria A
Radiated Immunity	10 V/m	EN61000-4-3, Criteria A
Fast Transient ⁽¹¹⁾	±2kV	EN61000-4-4, Criteria A
Surge ⁽¹¹⁾	±2kV	EN61000-4-5, Criteria A
Conducted Immunity	10 Vr.m.s	EN61000-4-6, Criteria A

Notes:

- Note10: The standard modules meet EMI Class A or Class B with external components, see filter suggestions below.
- Note11: An external input filter capacitor is required if the module has to meet EN61000-4-4, EN61000-4-5. The filter capacitor Recom suggests: Nippon chemi-con KY series, 220µF/100V.

continued on next page

RECOM

DC/DC Converter

RP20-AW Series

Specifications measured at $T_a = 25^\circ\text{C}$, nominal input voltage, full load otherwise noted

EMI Filtering Class B

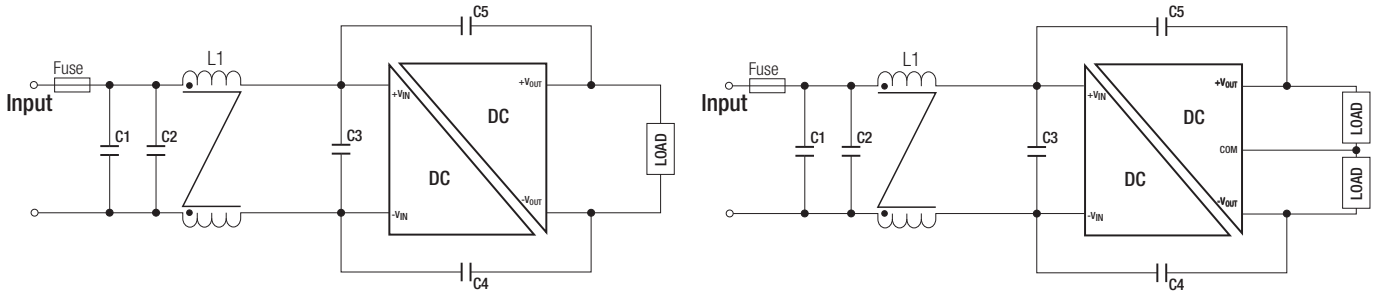

MODEL	C1	C2	C3	C4/C5	L1
RP20-24xxSAW RP20-24xxDAW	4.7 μF /25V 1812 MLCC	N/A	N/A	470pF/2kV 1808 MLCC	CMC: 325 μH ref.: WE 744290321 ref.: CMC-06
RP20-48xxSAW RP20-48xxDAW	2.2 μF /100V 1812 MLCC	2.2 μF /100V 1812 MLCC	2.2 μF /100V 1812 MLCC	470pF/2kV 1808 MLCC	CMC: 325 μH ref.: WE 744290321 ref.: CMC-06

DIMENSIONS and PHYSICAL CHARACTERISTICS

Parameter	Type	Value
Material	Case	Nickel coated copper
	Base	FR4 PCB
	Potting	Silicone (UL94-V0)
Package Dimensions (LxWxH)	without Heat-sink	25.4 x 25.4 x 9.9mm
	with Heat-sink	31.4 x 25.4 x 16.5mm
Package Weight	without Heat-sink	15g
	with Heat-sink	21.44g

Dimension Drawing (mm)

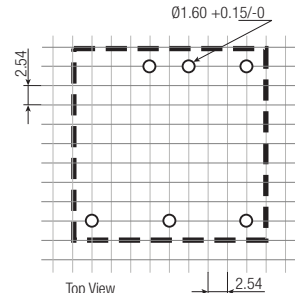
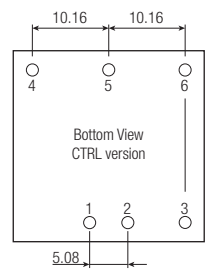
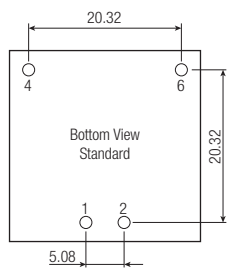
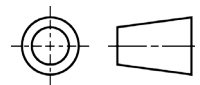
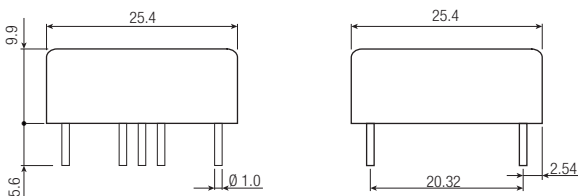

Pin Connections

Pin #	Single	Single /P or /N	Dual	Dual /P or /N
1	+Vin	+Vin	+Vin	+Vin
2	-Vin	-Vin	-Vin	-Vin
3	CTRL	CTRL	CTRL	CTRL
4	+Vout	+Vout	+Vout	+Vout
5	Trim	Trim	Com	Com
6	-Vout	-Vout	-Vout	-Vout

Pin Pitch Tolerance $\pm 0.25\text{mm}$
 Pin dimension tolerance $\pm 0.1\text{mm}$
 XX.X $\pm 0.5\text{mm}$
 XX.XX $\pm 0.25\text{mm}$

RECOM
DC/DC Converter

RP20-AW
Series

Specifications measured at Ta = 25°C, nominal input voltage, full load otherwise noted

Dimension Drawing (mm) with Heat-sink

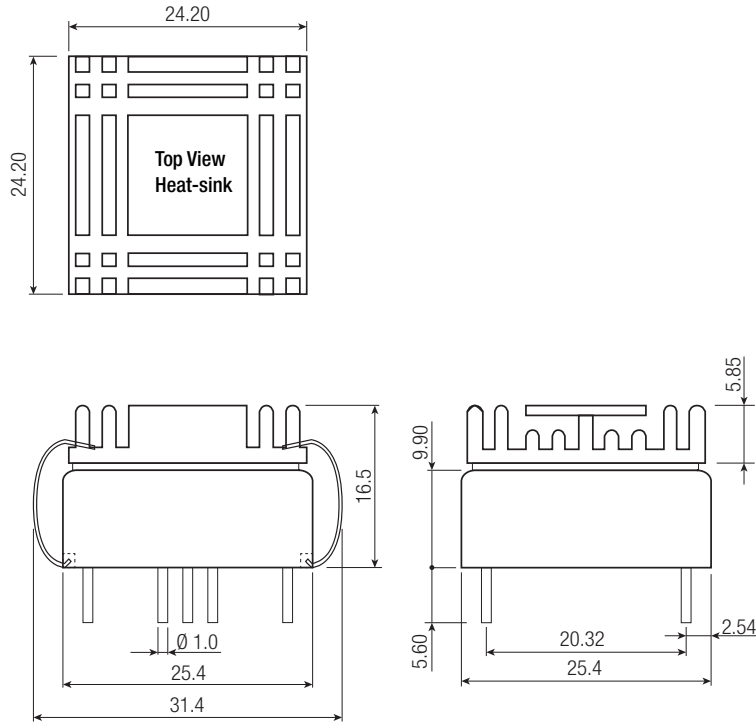

PACKAGING INFORMATION

Parameter	Type	Value
Packaging Quantity	without Heat-sink	8pcs.
	with Heat-sink	20pcs.
Storage Temperature Range		-55°C to +125°C
Storage Humidity		5% - 95% RH