

Excellent Integrated System Limited

Stocking Distributor

Click to view price, real time Inventory, Delivery & Lifecycle Information:

[Molex Connector Corporation](#)
[0397240005](#)

For any questions, you can email us directly:
sales@integrated-circuit.com

PART NUMBER DATA							
CIRCUITS	PART NUMBER	ENGINEERING NUMBER	COLOR	A IN mm	B IN mm		
2	397240002	M750S-03-5-02-3	GREEN	.60	15.2	.300	7.62
3	397240003	M750S-03-5-03-3	GREEN	.90	22.9	.600	15.24
4	397240004	M750S-03-5-04-3	GREEN	1.20	30.5	.900	22.86
5	397240005	M750S-03-5-05-3	GREEN	1.50	38.1	1.200	30.48
6	397240006	M750S-03-5-06-3	GREEN	1.80	45.7	1.500	38.10
7	397240007	M750S-03-5-07-3	GREEN	2.10	53.3	1.800	45.72
8	397240008	M750S-03-5-08-3	GREEN	2.40	61.0	2.100	53.34
9	397240009	M750S-03-5-09-3	GREEN	2.70	68.6	2.400	60.96
10	397240010	M750S-03-5-10-3	GREEN	3.00	76.2	2.700	68.58
11	397240011	M750S-03-5-11-3	GREEN	3.30	83.8	3.000	76.20
12	397240012	M750S-03-5-12-3	GREEN	3.60	91.4	3.300	83.82

REF. LAST 2 DIGITS OF PART NUMBER EQUALS NUMBER OF POLES

ENGINEERING NUMBER LEGEND

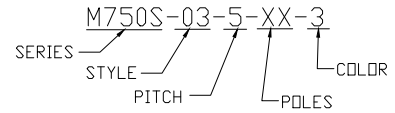

CONTACT FACTORY FOR OPTIONAL COLORS

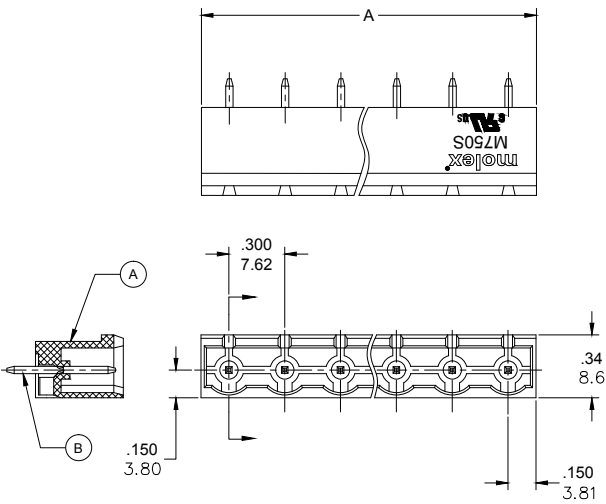
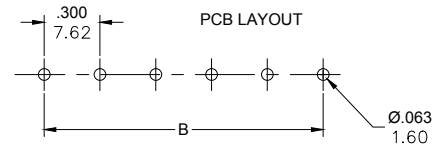

SPECIFICATIONS:

- MATERIAL:
 - A. BODY: PA66, UL94 V-0
 - B. TERMINAL: BRASS, TIN PLATED
- RATING: 15A AT 51-150V, 10A AT 151 TO 300V
- OPERATING TEMPERATURE: -40°C + 105°C
- DIELECTRIC VOLTAGE WITHSTAND: AC 2500V FOR 1 MINUTE.
- INSULATION RESISTANCE: DC 500V, 500MΩ
- RATED IMPULSE VOLTAGE: 4000V, PLUS AND MINUS 5 TIMES EACH.
- MAX. SOLDERING TEMPERATURE: +260°C FOR 5 SEC.
- MATES WITH TERMINAL PLUG SERIES: 39704
- DIMS SHOWN ARE FOR REFERENCE ONLY

RELEASED EC NO. IFC/2014/1194 DRAWN: RSTONE 2014/01/23 CHECKED: G. FARNS APPR: JFMURPHY 2014/10/16	QUALITY SYMBOLS ▽=0 ∇=0	GENERAL TOLERANCES (UNLESS SPECIFIED)		DIMENSION STYLE IN/MM		SCALE	DESIGN UNITS	THIRD ANGLE PROJECTION
		4 PLACES ±--- ±--- 3 PLACES ±--- ±.005 2 PLACES ±0.13 ±.01 1 PLACE ±0.3 ±--- ANGULAR ±---°	DRAWN BY RSTONE 2014/01/23 CHECKED BY G. FARNS APPROVED BY JFMURPHY 2014/10/16	DRAWN BY RSTONE 2014/01/23 CHECKED BY G. FARNS APPROVED BY JFMURPHY 2014/10/16	TITLE 7.62MM EURO HEADER VERTICAL, CLOSED END	MOLEX INCORPORATED	SHEET NO. 1 OF 1	
DRAFT WHERE APPLICABLE MUST REMAIN WITHIN DIMENSIONS		SEE CHART		DOCUMENT NO. SD-39724-001		THIS DRAWING CONTAINS INFORMATION THAT IS PROPRIETARY TO MOLEX INCORPORATED AND SHOULD NOT BE USED WITHOUT WRITTEN PERMISSION		