

Excellent Integrated System Limited

Stocking Distributor

Click to view price, real time Inventory, Delivery & Lifecycle Information:

[Cinch Connectivity Solutions](#)

[ATT-0225-18-TNC-02](#)

For any questions, you can email us directly:

sales@integrated-circuit.com



MODEL NUMBER
 ATT-0225-XX-TNC-02
 REV.
 E

NOTES:

- 1.0 ELECTRICAL SPECIFICATIONS:
 - 1.1 FREQUENCY RANGE: DC to 18.0 GHz
 - 1.2 ATTENUATION ACCURACY:
 - 1 to 6dB ±0.3dB
 - 7 to 20dB ±0.5dB
 - 21 to 40dB ±1.0dB
 - 41 to 60dB ±1.5dB
 - 1.3 IMPEDANCE: 50 OHMS
 - 1.4 MAXIMUM VSWR: 1.07+0.015f(GHz)
 - 1.5 MAXIMUM INPUT POWER: 2 WATTS AVG.
 AT +25°C DERATED LINEARLY TO
 0.5 WATTS AT +125°C.
 - 1.6 OPERATING TEMP. RANGE:
 -54°C to +125°C

2.0 MARKING: (MARK UNIT AS SHOWN)
 (REF.: INK-03339-27-XX)

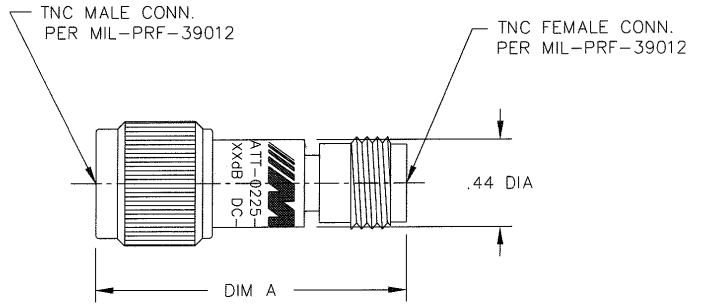

21-60	1.86
1-20	1.57
(dB)	DIM A
ATTEN.	

DWG NO. WAS: 02368-01-00

REV.	DESCRIPTION	DATE
-	RELEASED	2/21/79
A	ECR 1888	12/10/82
B	ECR 6545	5/29/89
C	ECN 10356	4/22/91
D	ECN 11779	4/30/92
D1	ADDED TITLERLOCK	2/21/05
E	ECN 20401	4/18/05

UNLESS OTHERWISE NOTED DIMENSIONS ARE IN INCHES AND TOLERANCES ARE: 3 PLACE DECIMALS ±.005 2 PLACE DECIMALS ±.02 FRACTIONS ±1/64 PARALLELITY: T.I.R. _____ FLATNESS: T.I.R. _____ CONCENTRICITY: T.I.R. _____ ANGLES AND PERPENDICULARITY: ±1°	FSCM NO. 34078	MIDWEST MICROWAVE
	NOTICE: The information contained in this drawing is proprietary and must not be used without the permission of Midwest Microwave	
TITLE ATTENUATOR		DRAWING NUMBER ATT-0225-XX-TNC-02
DRW/DATE A. BEATTY 4/30/92	ENG/DATE G. KOZAK 5/6/92	SCALE: 3=1 SHEET 1 of 1