

Excellent Integrated System Limited

Stocking Distributor

Click to view price, real time Inventory, Delivery & Lifecycle Information:

[Molex Connector Corporation](#)
[1510492401](#)

For any questions, you can email us directly:

sales@integrated-circuit.com

10 9 8 7 6 5 4 3 2 1

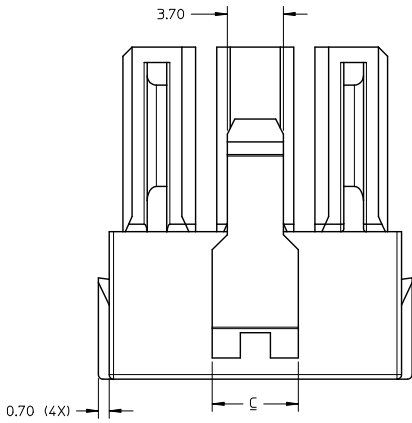
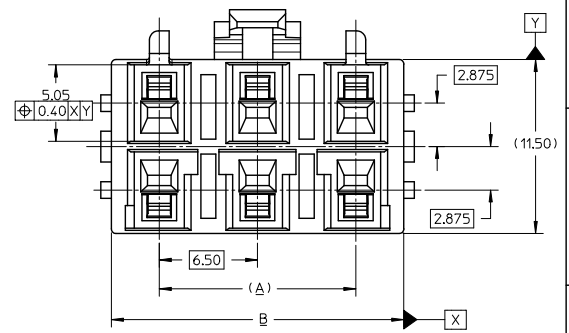
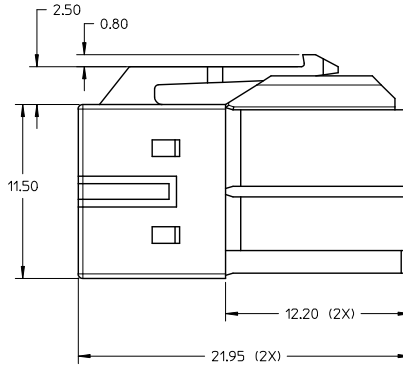
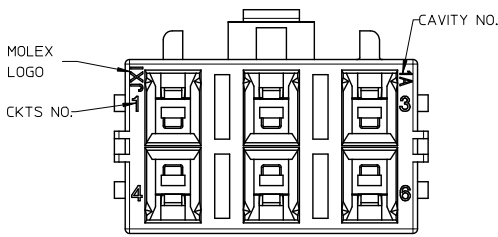

PART NO. LEGEND

151049 - * * * * *

— COLOR
— CKT NO.
— OTHERS

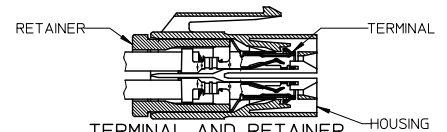

TERMINAL AND RETAINER ASSEMBLY DRAWING

NOTES:

1. MATERIAL: HOUSING: PBTP, UL94V-0
2. APPLICATION TERMINAL :
50597 (FOR WIRE RANGE #16-#22)
50598 (FOR WIRE RANGE #20-#26)
3. APPLICATION RETAINER : 51143
4. REFER TO COSMETIC SPECIFICATION: PS-45499-002(CLASS B)
5. MATE WITH HEADER 151048 SERIES
6. PRODUCT SPECIFICATION: PS-151048-0001
7. PACKAGING SPECIFICATION: PK-151049-0001

6	13.00	19.34	5.70	REFER TO PG 4
4	6.50	12.84	3.70	REFER TO PG 3
2	-	6.34	5.70	REFER TO PG 2
CKT. NO.	A	B	C	MATERIAL NO.

UPDATE DRAWING EC NO: S2015-1136 DRAWN BY: CHYD:CGOH CHECKED BY: KHL:IM DATE: 2015/07/10 DATE: 2015/07/21 DATE: 2015/07/22	QUALITY SYMBOLS √=0 ∇=0 ∇=0	GENERAL TOLERANCES (UNLESS SPECIFIED) 4 PLACES ± --- ± --- 3 PLACES ± --- ± --- 2 PLACES ± 0.20 ± --- 1 PLACE ± --- ± --- 0 PLACE ± --- ± --- ANGULAR ± 3 ° DRAFT WHERE APPLICABLE MUST REMAIN WITHIN DIMENSIONS	DIMENSION STYLE MM ONLY	SCALE NTS	DESIGN UNITS METRIC	THIRD ANGLE PROJECTION
			DRAWN BY: EANG DATE: 2014/03/13	TITLE SALES DRAWING 6.5 RECEPTACLE HOUSING WIRE TO BOARD CONNECTOR molex	DOCUMENT NO. SD-151049-0001	SHEET NO. 1 OF 4
			CHECKED BY: CGOH DATE: 2015/03/12	THIS DRAWING CONTAINS INFORMATION THAT IS PROPRIETARY TO MOLEX INCORPORATED AND SHOULD NOT BE USED WITHOUT WRITTEN PERMISSION		
			APPROVED BY: KHL:IM DATE: 2015/03/16	MATERIAL NO. SEE TABLE		

9 8 7 6 5 4 3 2 1

HOUSING WITH POLARIZATION FEATURES AND COLOR FOR 2CKTS

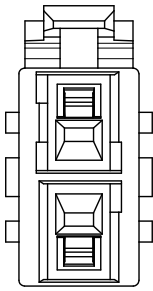

① 1510492200 ORANGE

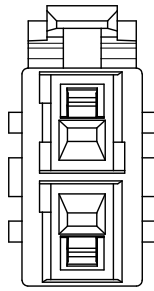

② 1510492201 BLUE

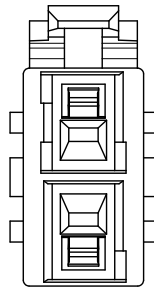

③ 1510492202 GREY

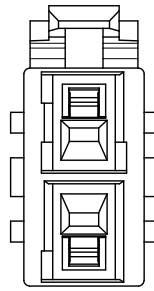

④ 1510492203 YELLOW

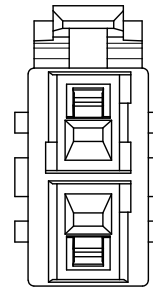

⑤ 1510492204 PURPLE

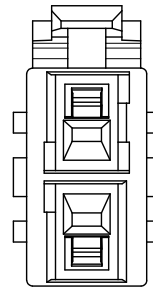

⑥ 1510492205 PINK

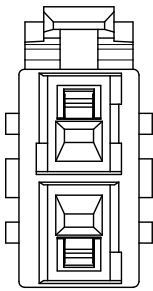

⑦ 1510492206 BLACK

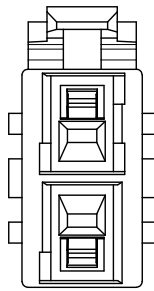

⑧ 1510492207 GREEN

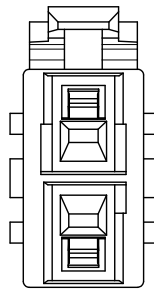

⑨ 1510492208 BROWN

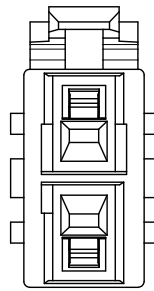

⑩ 1510492209 RED

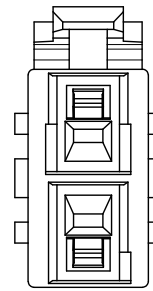

⑪ 1510492210 MINT

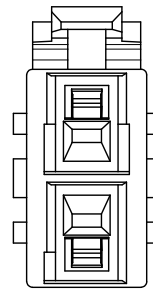

⑫ 1510492211 NATURAL (WHITE)

1	1510492200	ORANGE	*	
2	1510492201	BLUE	*	
3	1510492202	GREY		*
4	1510492203	YELLOW	*	
5	1510492204	PURPLE		*
6	1510492205	PINK		*
7	1510492206	BLACK	*	
8	1510492207	GREEN		*
9	1510492208	BROWN		*
10	1510492209	RED	*	
11	1510492210	MINT		*
12	1510492211	NATURAL (WHITE)	*	

CONFIGURATION	ASSEMBLY	COLOR	STANDARD COLOR	CUSTOM COLOR
---------------	----------	-------	----------------	--------------

UPDATE DRAWING	2015/07/10
EC NO. S2015-1136	2015/07/21
DRAWING	2015/07/21
CHKD:CGOH	2015/07/22
APPR:KLLIM	
REV	DESCRIPTION
6	QUALITY SYMBOLS

GENERAL TOLERANCES (UNLESS SPECIFIED)	
	mm INCH
4 PLACES	± --- ± ---
3 PLACES	± --- ± ---
2 PLACES	± 0.20 ± ---
1 PLACE	± --- ± ---
0 PLACE	± --- ± ---
ANGULAR ± 3°	
DRAFT WHERE APPLICABLE MUST REMAIN WITHIN DIMENSIONS	

DIMENSION STYLE	
MM ONLY	
DRAWN BY	DATE
EANG	2014/03/13
CHECKED BY	DATE
CGOH	2015/03/12
APPROVED BY	DATE
KHL IM	2015/03/16
MATERIAL NO.	SEE TABLE

SCALE	DESIGN UNITS	THIRD ANGLE PROJECTION
NTS	METRIC	
SALES DRAWING		
6.5 RECEPTACLE HOUSING		
WIRE TO BOARD CONNECTOR		
molex		
DOCUMENT NO.	SD-151049-0001	SHEET NO.
		2 OF 4

10 9 8 7 6 5 4 3 2 1

HOUSING WITH POLARIZATION FEATURES AND COLOR FOR 4CKTS

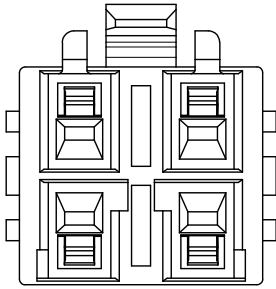

① 1510492401
BLUE

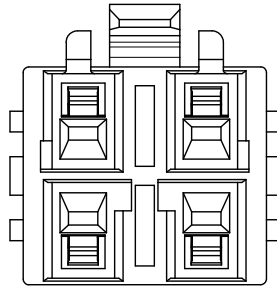

② 1510492406
BLACK

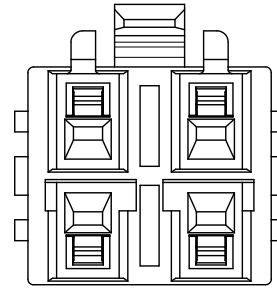

③ 1510492411
NATURAL (WHITE)

1	1510492401	BLUE
2	1510492406	BLACK
3	1510492411	NATURAL (WHITE)
CONFIGURATION	ASSEMBLY	COLOR

fb_frame_A3_P_AM_T
Rev. G 2012/01/11

UPDATE DRAWING EC NO: S2015-1136 DRAWING: 2015/07/10 CHKD:CGOH 2015/07/21 APPR:KHLIM 2015/07/22 REV 6	QUALITY SYMBOLS	GENERAL TOLERANCES (UNLESS SPECIFIED)	DIMENSION STYLE	SCALE	DESIGN UNITS	THIRD ANGLE PROJECTION																		
	$\nabla=0$ $\nabla=0$ $\nabla=0$	<table border="1"> <tr> <th></th> <th>mm</th> <th>INCH</th> </tr> <tr> <td>4 PLACES</td> <td>±---</td> <td>±---</td> </tr> <tr> <td>3 PLACES</td> <td>±---</td> <td>±---</td> </tr> <tr> <td>2 PLACES</td> <td>±0.20</td> <td>±---</td> </tr> <tr> <td>1 PLACE</td> <td>±---</td> <td>±---</td> </tr> <tr> <td>0 PLACE</td> <td>±---</td> <td>±---</td> </tr> </table>		mm	INCH	4 PLACES	±---	±---	3 PLACES	±---	±---	2 PLACES	±0.20	±---	1 PLACE	±---	±---	0 PLACE	±---	±---	MM ONLY	NTS	METRIC	
		mm	INCH																					
	4 PLACES	±---	±---																					
	3 PLACES	±---	±---																					
	2 PLACES	±0.20	±---																					
1 PLACE	±---	±---																						
0 PLACE	±---	±---																						
DESCRIPTION	ANGULAR ± 3°	DRAWN BY	DATE	TITLE																				
	DRAFT WHERE APPLICABLE MUST REMAIN WITHIN DIMENSIONS	EANG	2014/03/13	SALES DRAWING																				
		CHECKED BY	DATE	6.5 RECEPTACLE HOUSING																				
		CGOH	2015/03/12	WIRE TO BOARD CONNECTOR																				
		APPROVED BY	DATE	molex																				
		KHLIM	2015/03/16	DOCUMENT NO. SD-151049-0001																				
		MATERIAL NO.	SEE TABLE	SHEET NO. 3 OF 4																				
		SIZE	A3	THIS DRAWING CONTAINS INFORMATION THAT IS PROPRIETARY TO MOLEX INCORPORATED AND SHOULD NOT BE USED WITHOUT WRITTEN PERMISSION																				

10 9 8 7 6 5 4 3 2 1

10 9 8 7 6 5 4 3 2 1

HOUSING WITH POLARIZATION FEATURES AND COLOR FOR 6CKTS

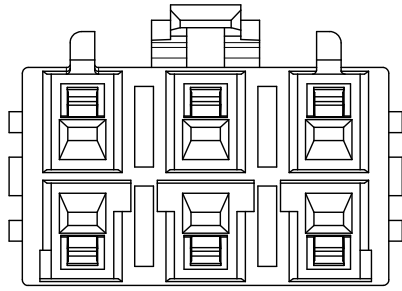

① 1510492601
BLUE

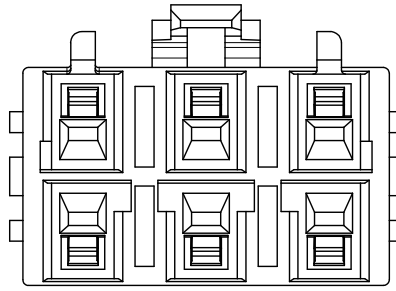

② 1510492606
BLACK

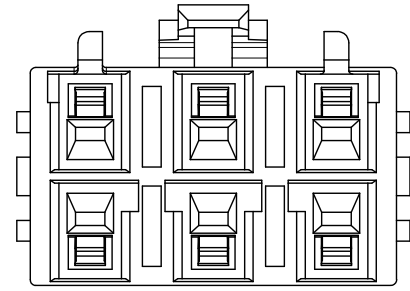

③ 1510492609
RED

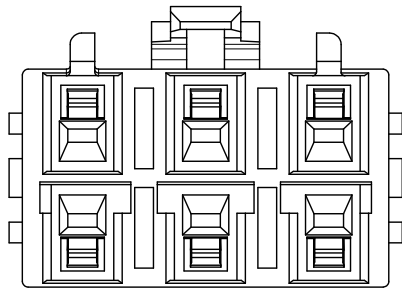

④ 1510492611
NATURAL (WHITE)

1	1510492601	BLUE
2	1510492606	BLACK
3	1510492609	RED
4	1510492611	NATURAL (WHITE)

CONFIGURATION	ASSEMBLY	COLOR
---------------	----------	-------

UPDATE DRAWING EC NO: S2015-1136 DRAWING: 2015/07/10 CHKD: CGOH 2015/07/21 APPR: KHLIM 2015/07/22 REV 6	QUALITY SYMBOLS	GENERAL TOLERANCES (UNLESS SPECIFIED)	DIMENSION STYLE	SCALE	DESIGN UNITS	THIRD ANGLE PROJECTION
	$\nabla=0$ $\nabla=0$ $\nabla=0$	mm INCH 4 PLACES ± --- ± --- 3 PLACES ± --- ± --- 2 PLACES ± 0.20 ± --- 1 PLACE ± --- ± --- 0 PLACE ± --- ± ---	MM ONLY	NTS	METRIC	
		ANGULAR ± 3°	DRAWN BY	DATE	TITLE	
		DRAFT WHERE APPLICABLE MUST REMAIN WITHIN DIMENSIONS	EANG	2014/03/13	SALES DRAWING	
			CHECKED BY	DATE	6.5 RECEPTACLE HOUSING	
			CGOH	2015/03/12	WIRE TO BOARD CONNECTOR	
		APPROVED BY	DATE	molex		
		KHLIM	2015/03/16	DOCUMENT NO. SD-151049-0001		
		MATERIAL NO.	SEE TABLE	SHEET NO. 4 OF 4		
		SIZE	A3	THIS DRAWING CONTAINS INFORMATION THAT IS PROPRIETARY TO MOLEX INCORPORATED AND SHOULD NOT BE USED WITHOUT WRITTEN PERMISSION		

10 9 8 7 6 5 4 3 2 1