

Excellent Integrated System Limited

Stocking Distributor

Click to view price, real time Inventory, Delivery & Lifecycle Information:

[Molex Connector Corporation](#)
[43640-0701](#)

For any questions, you can email us directly:

sales@integrated-circuit.com

ASSEMBLY ITEM NUMBER	PART CHARACTERISTICS NUMBER OF POSITION
43640-0200	02
43640-0300	03
43640-0400	04
43640-0500	05
43640-0600	06
43640-0700	07
43640-0800	08
43640-0900	09
43640-1000	10
43640-1100	11
43640-1200	12

CKT. NO.	DIM. 'A'	DIM. 'B'	DIM. 'C'	DIM. 'D'
2	.270/6.85	.118/3.00	.284/7.21	.429/10.90
3	.388/9.85	.236/6.00	.402/10.21	.547/13.89
4	.506/12.85	.354/9.00	.520/13.21	.665/16.89
5	.624/15.85	.472/12.00	.638/16.21	.783/19.89
6	.742/18.85	.591/15.00	.756/19.21	.901/22.89
7	.860/21.85	.709/18.00	.874/22.20	1.019/25.88
8	.978/24.85	.872/21.00	.992/25.20	1.137/28.88
9	1.096/27.85	.945/24.00	1.110/28.20	1.255/31.88
10	1.215/30.85	1.063/27.00	1.229/31.22	1.373/34.87
11	1.333/33.85	1.181/30.00	1.347/34.22	1.491/37.87
12	1.451/36.85	1.299/33.00	1.465/37.22	1.609/40.87

NOTES:

- HOUSING MATERIAL: UNFILLED NYLON, RATED UL94V-0 COLOR IS BLACK. (HALOGEN-FREE)
- FINISH: NONE
- PRODUCT SPECIFICATION: PS-43650
- PACKAGING SPECIFICATION: PK-43640-003
- THIS HOUSING MATES WITH MICRO-FIT RECEPTACLE #43645-****.
- THIS HOUSING IS DESIGNED IN METRIC
- THIS HOUSING TO BE USED WITH MOLEX MALE TERMINAL #43031-****.
- PLUG DESIGNED FOR .062/1.57 TO .090/2.30 THICK STAMPED PANEL OR PRINTED CIRCUIT BOARD.
- SEE SECTION "D"-D" FOR TERMINAL ORIENTATION IN HOUSING.
- SEE SHEET 2 FOR PLUG WITHOUT PANEL MOUNTS.
- PANEL MOUNT FEATURES MUST LOCK ON SIDE OPPOSITE PUNCH SIDE FOR OPTIMUM RETENTION.
- LAST CIRCUIT INDICATOR IS NOT PRESENT ON 2 CIRCUIT HOUSING.
- THIS PART CONFORMS TO CLASS B REQUIREMENTS OF COSMETIC SPECIFICATION PS-45499-002.

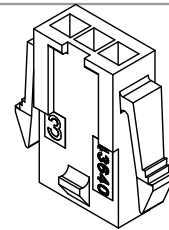

PLUG WITH PANEL MOUNTS

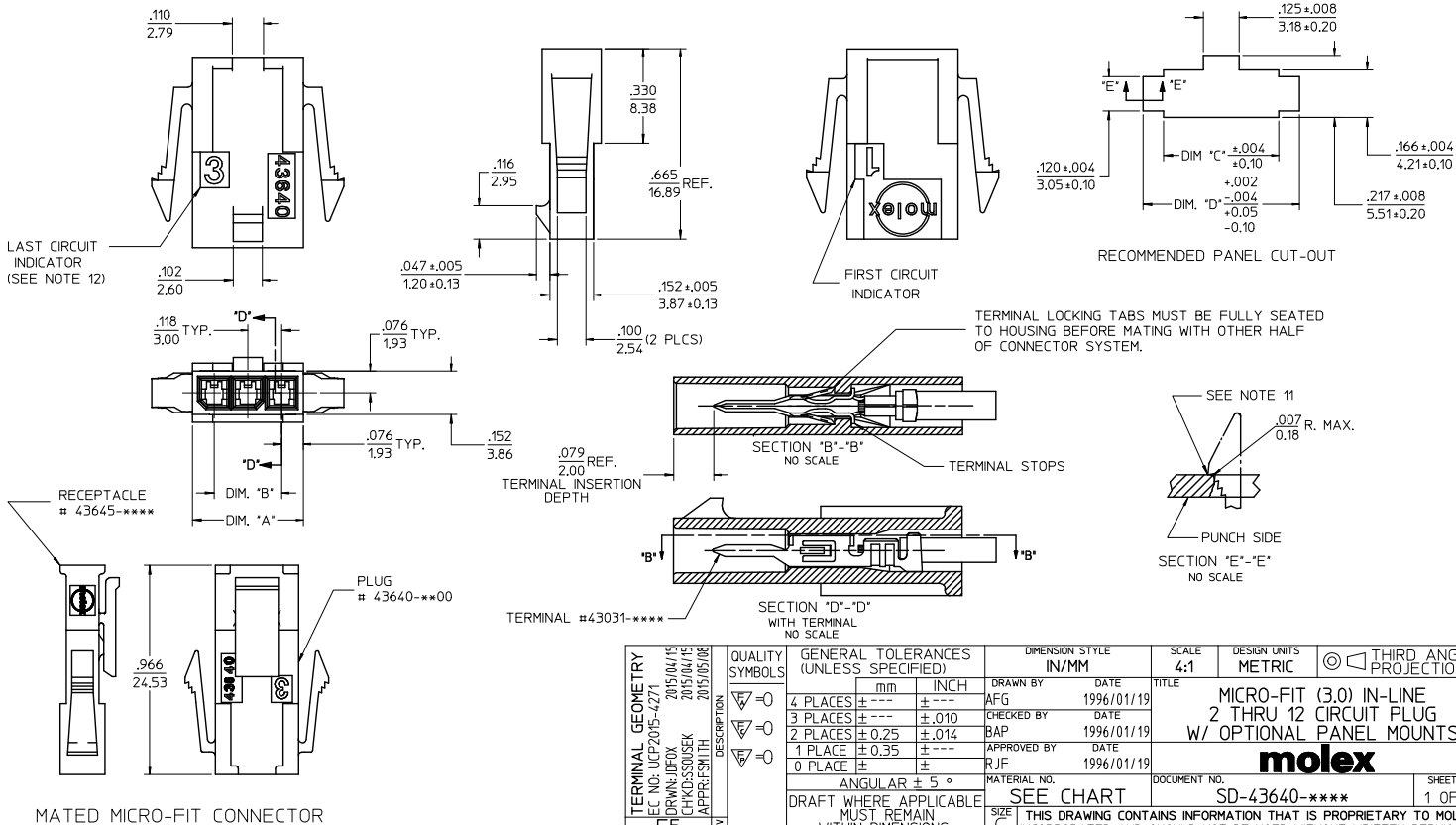

TERMINAL GEOMETRY	QUALITY SYMBOLS	GENERAL TOLERANCES (UNLESS SPECIFIED)		DIMENSION STYLE		SCALE	DESIGN UNITS	THIRD ANGLE PROJECTION
		mm	INCH	IN/MM	DATE			
4 PLACES ± .010	∇=0	± .010	± .004	IN/MM	1996/01/19	4:1	METRIC	THIRD ANGLE PROJECTION
3 PLACES ± .025	∇=0	± .010	± .014	IN/MM	1996/01/19			
2 PLACES ± 0.35	∇=0	± .010	± .014	IN/MM	1996/01/19			
1 PLACE ± 0.35	∇=0	± .010	± .014	IN/MM	1996/01/19			
0 PLACE ±	∇=0	± .010	± .014	IN/MM	1996/01/19			

TERMINAL GEOMETRY	EC NO: UCP2015-4271	2015/04/15	2015/04/15	2015/05/08
DRAWN BY	CHKD BY	APPROVED BY	DATE	DATE
AFG	BAP	RJF	1996/01/19	1996/01/19

MATERIAL NO.	DOCUMENT NO.	SHEET NO.
SEE CHART	SD-43640-****	1 OF 2

ASSEMBLY ITEM NUMBER	PART CHARACTERISTICS NUMBER OF POSITION
43640-0201	02
43640-0301	03
43640-0401	04
43640-0501	05
43640-0601	06
43640-0701	07
43640-0801	08
43640-0901	09
43640-1001	10
43640-1101	11
43640-1201	12

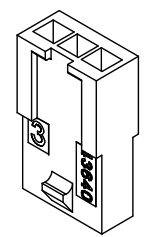
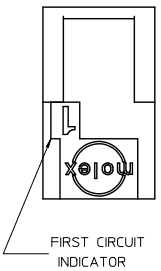
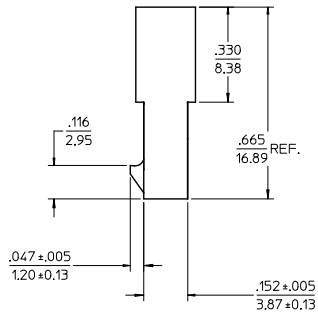
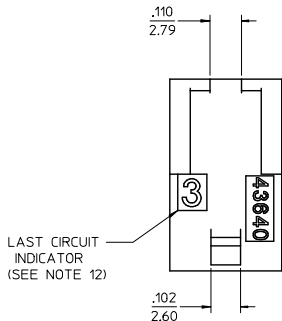

PLUG WITHOUT PANEL MOUNTS

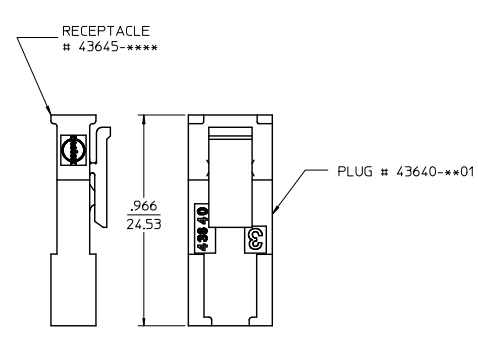
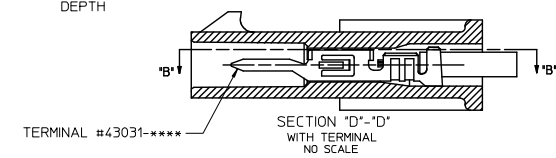
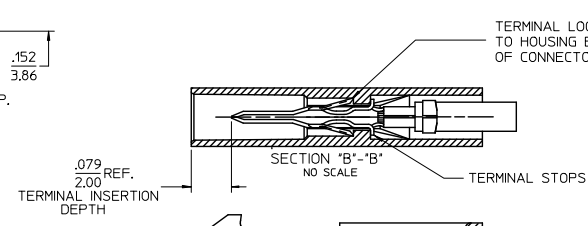
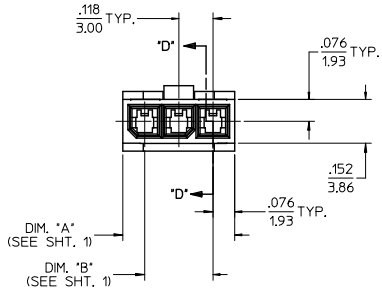

MATED MICRO-FIT CONNECTOR

TERMINAL GEOMETRY EC NO: UCP2015-4271 DRAWN BY: 2015/04/15 CHKD BY: 2015/04/15 APPROVED BY: 2015/05/08	QUALITY SYMBOLS ∇=0 ∇=0 ∇=0	GENERAL TOLERANCES (UNLESS SPECIFIED)		DIMENSION STYLE IN/MM		SCALE 4:1	DESIGN UNITS METRIC	THIRD ANGLE PROJECTION		
		4 PLACES ± --- ± ---	mm	INCH	DRAWN BY	DATE	TITLE MICRO-FIT (3.0) IN-LINE 2 THRU 12 CIRCUIT PLUG W/ OPTIONAL PANEL MOUNTS molex MATERIAL NO. DOCUMENT NO. SD-43640-**** SHEET NO. 2 OF 2			
		3 PLACES ± --- ± .010			CHECKED BY	DATE				
		2 PLACES ± 0.25 ± .014			BAP	1996/01/19				
1 PLACE ± 0.35 ± ---			APPROVED BY	DATE						
0 PLACE ± --- ± ---			RJF	1996/01/19						
DRAFT WHERE APPLICABLE MUST REMAIN WITHIN DIMENSIONS		SEE CHART		THIS DRAWING CONTAINS INFORMATION THAT IS PROPRIETARY TO MOLEX INCORPORATED AND SHOULD NOT BE USED WITHOUT WRITTEN PERMISSION						