

Excellent Integrated System Limited

Stocking Distributor

Click to view price, real time Inventory, Delivery & Lifecycle Information:

[STMicroelectronics](#)
[STPS80H100CY](#)

For any questions, you can email us directly:

sales@integrated-circuit.com



STPS80H100C

High voltage power Schottky rectifier

Features

- High reverse voltage
- Negligible switching losses
- Low forward voltage drop
- Low leakage current
- High temperature
- Low thermal resistance
- Avalanche capability specified

Description

Dual center tap Schottky rectifier suited for Switched Mode Power Supplies and high frequency DC to DC converters.

Packaged in Max247, this device is intended for use in high frequency computer and telecom converters.

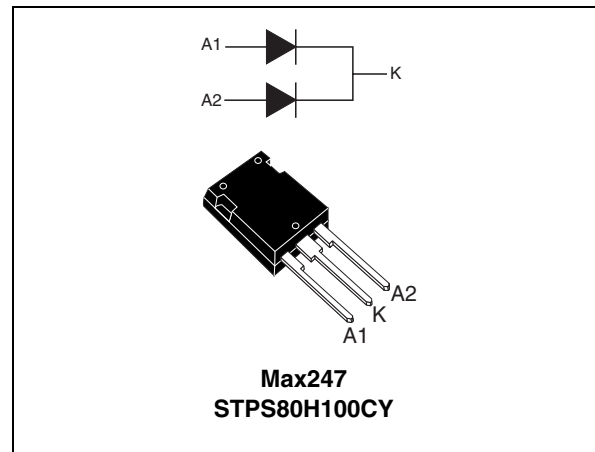

Table 1. Device summary

Symbol	Value
$I_{F(AV)}$	2 x 40 A
V_{RRM}	100 V
T_j (max)	175 °C
V_F (max)	0.70 V

Characteristics

STPS80H100C

1 Characteristics

Table 2. Absolute ratings (limiting values, per diode)

Symbol	Parameter		Value	Unit
V _{RRM}	Repetitive peak reverse voltage		100	V
I _{F(RMS)}	Forward rms current		50	A
I _{F(AV)}	Average forward current	T _c = 155 °C δ = 0.5	Per diode 80	A
I _{FSM}	Surge non repetitive forward current	t _p = 10 ms sinusoidal	400	A
I _{RRM}	Repetitive peak reverse current	t _p = 2 μs, F = 1 kHz	2	A
P _{ARM}	Repetitive peak avalanche power	t _p = 1 μs, T _j = 25 °C	39200	W
T _{stg}	Storage temperature range		-65 to + 175	°C
T _j	Maximum operating junction temperature ⁽¹⁾		175	°C
dV/dt	Critical rate of rise of reverse voltage		10000	V/μs

1. $\frac{dP_{tot}}{dT_j} < \frac{1}{R_{th(j-a)}}$ condition to avoid thermal runaway for a diode on its own heatsink

Table 3. Thermal resistance

Symbol	Parameter		Value	Unit
R _{th(j-c)}	Junction to case	Per diode Total	0.7 0.5	°C/W
R _{th(c)}	Coupling		0.3	

When the diodes 1 and 2 are used simultaneously :

$$\Delta T_j(\text{diode 1}) = P(\text{diode1}) \times R_{th(j-c)}(\text{Per diode}) + P(\text{diode 2}) \times R_{th(c)}$$

Table 4. Static electrical characteristics

Symbol	Parameter	Test conditions		Min.	Typ.	Max.	Unit
I _R ⁽¹⁾	Reverse leakage current	T _j = 25 °C	V _R = V _{RRM}			20	μA
		T _j = 125 °C			7	20	mA
V _F ⁽²⁾	Forward voltage drop	T _j = 25 °C	I _F = 40 A			0.8	V
		T _j = 125 °C	I _F = 40 A		0.65	0.7	
		T _j = 25 °C	I _F = 80 A			0.94	
		T _j = 125 °C	I _F = 80 A		0.79	0.84	

1. Pulse test: t_p = 5 ms, δ < 2%

2. Pulse test: t_p = 380 μs, δ < 2%

To evaluate the conduction losses use the following equation:

$$P = 0.5 \times I_{F(AV)} + 0.0055 I_{F(RMS)}^2$$

STPS80H100C

Characteristics

Figure 1. Average forward power dissipation versus average forward current (per diode)

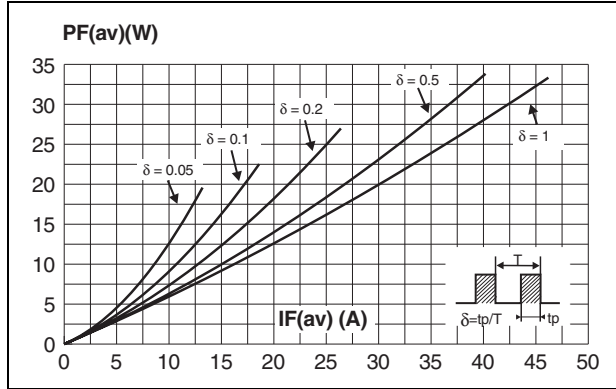

Figure 2. Average forward current versus ambient temperature ($\delta = 0.5$, per diode)

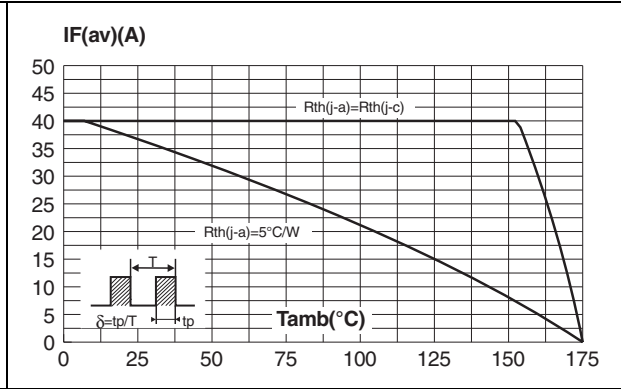

Figure 3. Normalized avalanche power derating versus pulse duration

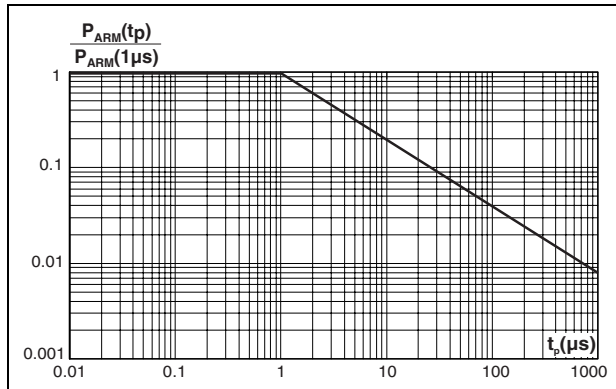

Figure 4. Normalized avalanche power derating versus junction temperature

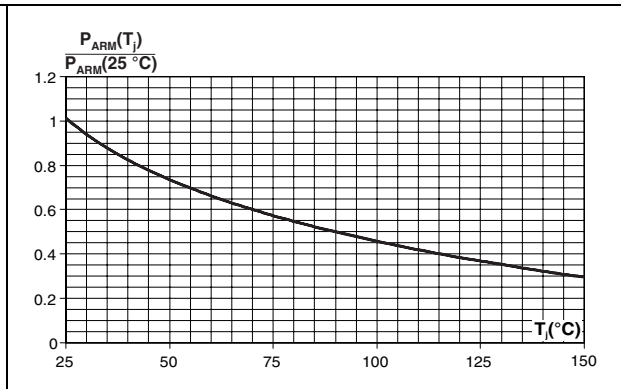

Figure 5. Non repetitive surge peak forward current versus overload duration (maximum values, per diode)

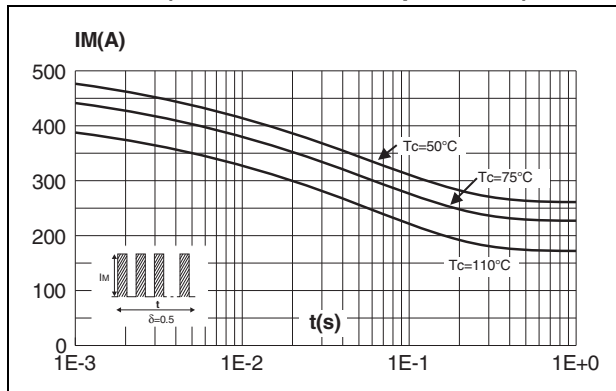
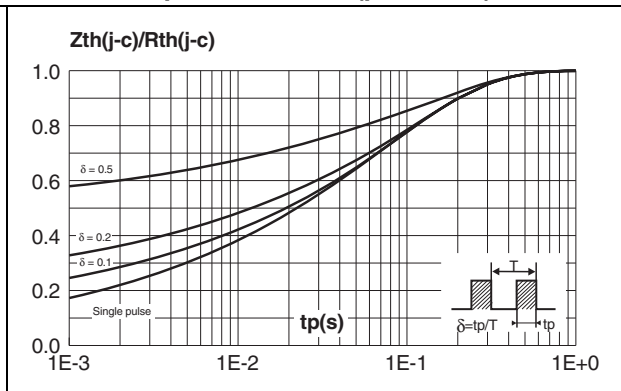

Figure 6. Relative variation of thermal impedance junction to case versus pulse duration (per diode)



Characteristics

STPS80H100C

Figure 7. Reverse leakage current versus reverse voltage applied (typical values, per diode)

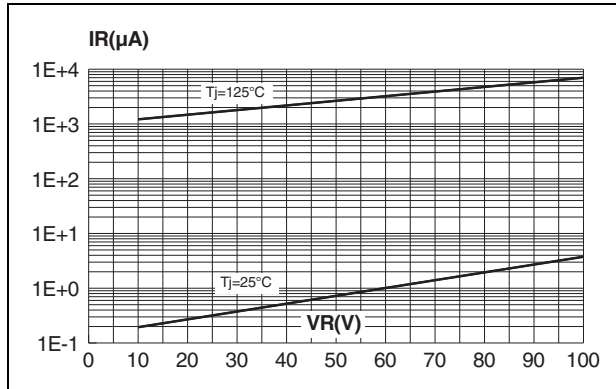

Figure 8. Junction capacitance versus reverse voltage applied (typical values, per diode)

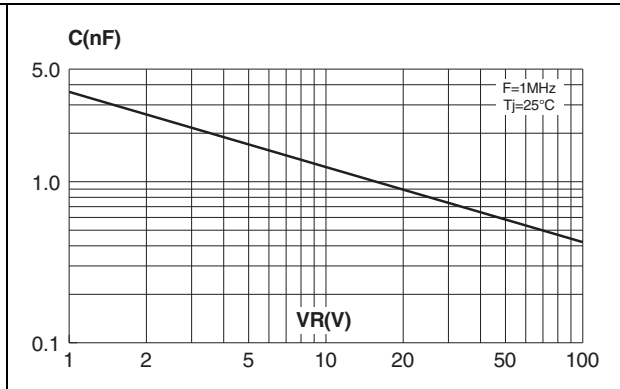
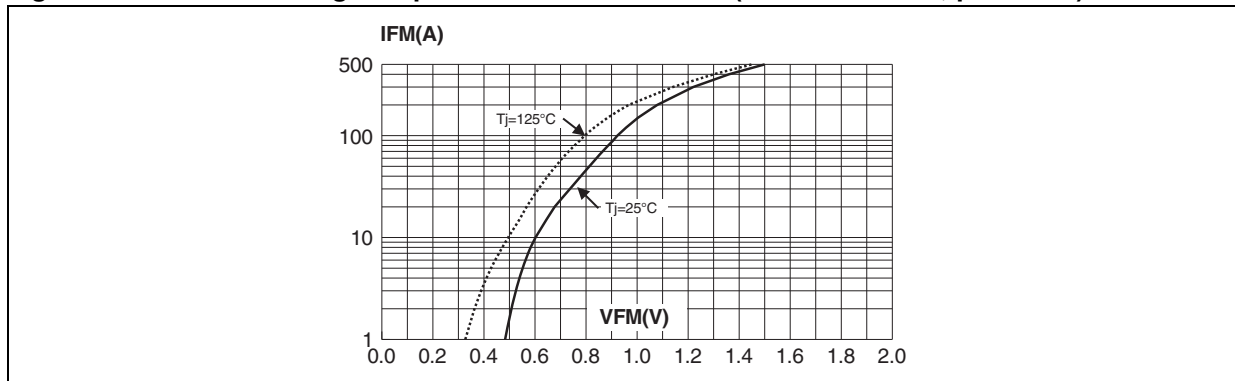

Figure 9. Forward voltage drop versus forward current (maximum value, per diode)



STPS80H100C

Package information

2 Package information

- Epoxy meets UL94, V0
- Lead-free packages

In order to meet environmental requirements, ST offers these devices in different grades of ECOPACK® packages, depending on their level of environmental compliance. ECOPACK® specifications, grade definitions and product status are available at: www.st.com. ECOPACK® is an ST trademark.

Table 5. Max247 dimensions

Ref.	Dimensions			
	Millimeters		Inches	
	Min.	Max.	Min.	Max.
A	4.70	5.30	0.185	0.209
A1	2.20	2.60	0.087	0.102
b	1.00	1.40	0.038	0.055
b1	2.00	2.40	0.079	0.094
b2	3.00	3.40	0.118	0.133
c	0.40	0.80	0.016	0.031
D	19.70	20.30	0.776	0.799
e	5.35	5.55	0.211	0.219
E	15.30	15.90	0.602	0.626
L	14.20	15.20	0.559	0.598
L1	3.70	4.30	0.146	0.169

3 Ordering information

Table 6. Ordering information

Order code	Marking	Package	Weight	Base qty	Delivery mode
STPS80H100CY	STPS80H100CY	Max247	4.4 g	30	Tube

4 Revision history

Table 7. Document revision history

Date	Revision	Change
July-2003	2B	Last release.
21-Jun-2010	3	Updated package illustration on page 1 and Section 2: Package information on page 5 .

STPS80H100C

Please Read Carefully:

Information in this document is provided solely in connection with ST products. STMicroelectronics NV and its subsidiaries ("ST") reserve the right to make changes, corrections, modifications or improvements, to this document, and the products and services described herein at any time, without notice.

All ST products are sold pursuant to ST's terms and conditions of sale.

Purchasers are solely responsible for the choice, selection and use of the ST products and services described herein, and ST assumes no liability whatsoever relating to the choice, selection or use of the ST products and services described herein.

No license, express or implied, by estoppel or otherwise, to any intellectual property rights is granted under this document. If any part of this document refers to any third party products or services it shall not be deemed a license grant by ST for the use of such third party products or services, or any intellectual property contained therein or considered as a warranty covering the use in any manner whatsoever of such third party products or services or any intellectual property contained therein.

UNLESS OTHERWISE SET FORTH IN ST'S TERMS AND CONDITIONS OF SALE ST DISCLAIMS ANY EXPRESS OR IMPLIED WARRANTY WITH RESPECT TO THE USE AND/OR SALE OF ST PRODUCTS INCLUDING WITHOUT LIMITATION IMPLIED WARRANTIES OF MERCHANTABILITY, FITNESS FOR A PARTICULAR PURPOSE (AND THEIR EQUIVALENTS UNDER THE LAWS OF ANY JURISDICTION), OR INFRINGEMENT OF ANY PATENT, COPYRIGHT OR OTHER INTELLECTUAL PROPERTY RIGHT.

UNLESS EXPRESSLY APPROVED IN WRITING BY AN AUTHORIZED ST REPRESENTATIVE, ST PRODUCTS ARE NOT RECOMMENDED, AUTHORIZED OR WARRANTED FOR USE IN MILITARY, AIR CRAFT, SPACE, LIFE SAVING, OR LIFE SUSTAINING APPLICATIONS, NOR IN PRODUCTS OR SYSTEMS WHERE FAILURE OR MALFUNCTION MAY RESULT IN PERSONAL INJURY, DEATH, OR SEVERE PROPERTY OR ENVIRONMENTAL DAMAGE. ST PRODUCTS WHICH ARE NOT SPECIFIED AS "AUTOMOTIVE GRADE" MAY ONLY BE USED IN AUTOMOTIVE APPLICATIONS AT USER'S OWN RISK.

Resale of ST products with provisions different from the statements and/or technical features set forth in this document shall immediately void any warranty granted by ST for the ST product or service described herein and shall not create or extend in any manner whatsoever, any liability of ST.

ST and the ST logo are trademarks or registered trademarks of ST in various countries.

Information in this document supersedes and replaces all information previously supplied.

The ST logo is a registered trademark of STMicroelectronics. All other names are the property of their respective owners.

© 2010 STMicroelectronics - All rights reserved

STMicroelectronics group of companies

Australia - Belgium - Brazil - Canada - China - Czech Republic - Finland - France - Germany - Hong Kong - India - Israel - Italy - Japan - Malaysia - Malta - Morocco - Philippines - Singapore - Spain - Sweden - Switzerland - United Kingdom - United States of America

www.st.com