

Excellent Integrated System Limited

Stocking Distributor

Click to view price, real time Inventory, Delivery & Lifecycle Information:

[Analog Devices Inc.](#)
[AD8564AR](#)

For any questions, you can email us directly:

sales@integrated-circuit.com



Quad 7 ns Single Supply Comparator

AD8564

FEATURES

- 5 V single-supply operation
- 7 ns propagation delay
- Low power
- Separate input and output sections
- TTL/CMOS logic-compatible outputs
- Wide output swing
- TSSOP, SOIC, and PDIP packages

APPLICATIONS

- High speed timing
- Line receivers
- Data communications
- High speed V-to-F converters
- Battery operated instrumentation
- High speed sampling systems
- Window comparators
- PCMCIA cards
- Upgrade for MAX901 designs

PIN CONFIGURATIONS

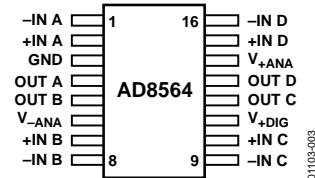

Figure 1. 16-Lead TSSOP (RU-16)

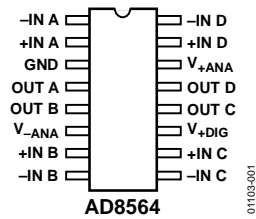

Figure 2. 16-Lead Narrow Body SOIC (R-16)

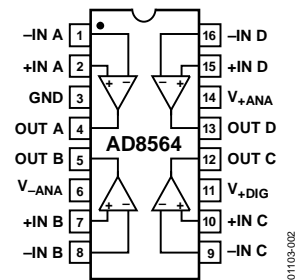

Figure 3. 16-Lead PDIP (N-16)

GENERAL DESCRIPTION

The AD8564 is a quad 7 ns comparator with separate input and output supplies, thus enabling the input stage to be operated from ± 5 V dual supplies or a 5 V single supply while maintaining a CMOS-/TTL-compatible output.

Fast 7 ns propagation delay makes the AD8564 a good choice for timing circuits and line receivers. Independent analog and digital supplies provide excellent protection from supply pin interaction. The AD8564 is pin compatible with the MAX901 and has lower supply currents.

All four comparators have similar propagation delays. The propagation delay for rising and falling signals is similar, and tracks over temperature and voltage. These characteristics make the AD8564 a good choice for high speed timing and data communications circuits. For a similar single comparator with latch function, refer to the AD8561 data sheet.

The AD8564 is specified over the industrial temperature range (-40°C to $+125^{\circ}\text{C}$). The quad AD8564 is available in the 16-lead TSSOP, 16-lead narrow body SOIC, and 16-lead plastic DIP packages.

Rev. B

Information furnished by Analog Devices is believed to be accurate and reliable. However, no responsibility is assumed by Analog Devices for its use, nor for any infringements of patents or other rights of third parties that may result from its use. Specifications subject to change without notice. No license is granted by implication or otherwise under any patent or patent rights of Analog Devices. Trademarks and registered trademarks are the property of their respective owners.

AD8564

TABLE OF CONTENTS

Features	1	ESD Caution.....	5
Applications.....	1	Typical Performance Characteristics	6
Pin Configurations	1	Applications Information	9
General Description	1	Optimizing High Speed Performance	9
Revision History	2	Output Loading Considerations.....	9
Specifications.....	3	Input Stage and Bias Currents	9
Electrical Specifications.....	3	Using Hysteresis	10
Absolute Maximum Ratings.....	5	Outline Dimensions	11
Thermal Resistance	5	Ordering Guide	12

REVISION HISTORY

8/07—Rev. A to Rev. B

Updated Format.....	Universal
Changes to Applications	1
Changes to General Description	1
Changes to Specifications	3
Changes to the Absolute Maximum Ratings Section	5
Changes to the Applications Information Section	9
Deleted Spice Model Section.....	11
Updated Outline Dimensions	12
Changes to Ordering Guide	13

6/99—Rev. 0 to Rev. A

SPECIFICATIONS

ELECTRICAL SPECIFICATIONS

$V_{+ANA} = V_{+DIG} = 5.0\text{ V}$, $V_{-ANA} = 0\text{ V}$, $T_A = 25^\circ\text{C}$, unless otherwise noted.

Table 1.

Parameter	Symbol	Conditions	Min	Typ	Max	Unit
INPUT CHARACTERISTICS						
Offset Voltage	V_{OS}	$-40^\circ\text{C} \leq T_A \leq +125^\circ\text{C}^1$		2.3	7	mV
Offset Voltage Drift	$\Delta V_{OS}/\Delta T$			4	8	$\mu\text{V}/^\circ\text{C}$
Input Bias Current	I_B	$V_{CM} = 0\text{ V}$ $-40^\circ\text{C} \leq T_A \leq +125^\circ\text{C}^1$			± 4	μA
Input Offset Current	I_{OS}	$V_{CM} = 0\text{ V}$			± 3	μA
Input Common-Mode Voltage Range	V_{CM}		0		2.75	V
Common-Mode Rejection Ratio	CMRR	$0\text{ V} \leq V_{CM} \leq 3.0\text{ V}$	65	85		dB
Large Signal Voltage Gain	A_{VO}	$R_L = 10\text{ k}\Omega$		3000		V/V
Input Capacitance	C_{IN}			3.0		pF
DIGITAL OUTPUTS						
Logic 1 Voltage	V_{OH}	$I_{OH} = -3.2\text{ mA}$, $\Delta V_{IN} > 250\text{ mV}$	2.4	3.5		V
Logic 0 Voltage	V_{OL}	$I_{OL} = 3.2\text{ mA}$, $V_{IN} > 250\text{ mV}$		0.3	0.4	V
DYNAMIC PERFORMANCE²						
Propagation Delay	t_p	200 mV step with 100 mV overdrive $-40^\circ\text{C} \leq T_A \leq +125^\circ\text{C}^1$		6.75	9.8	ns
		100 mV step with 5 mV overdrive		8		ns
Differential Propagation Delay (Rising Propagation Delay vs. Falling Propagation Delay)	Δt_p	100 mV step with 20 mV overdrive		0.5	2.0	ns
Rise Time		20% to 80%		3.8		ns
Fall Time		20% to 80%		1.5		ns
POWER SUPPLY						
Power Supply Rejection Ratio	PSRR	$4.5\text{ V} \leq V_{+ANA}$ and $V_{+DIG} \leq 5.5\text{ V}$		80		dB
Analog Supply Current	I_{+ANA}	$-40^\circ\text{C} \leq T_A \leq +85^\circ\text{C}^1$		10.5	14.0	mA
		$-40^\circ\text{C} \leq T_A \leq +125^\circ\text{C}^1$			15.6	mA
		$-40^\circ\text{C} \leq T_A \leq +125^\circ\text{C}^1$			17	mA
Digital Supply Current	I_{DIG}	$V_O = 0\text{ V}$, $R_L = \infty$ $-40^\circ\text{C} \leq T_A \leq +125^\circ\text{C}^1$		6.0	7.0	mA
					8.0	mA
Analog Supply Current	I_{-ANA}	$-40^\circ\text{C} \leq T_A \leq +85^\circ\text{C}^1$		-7.0	+14.0	mA
		$-40^\circ\text{C} \leq T_A \leq +125^\circ\text{C}^1$			15.6	mA
		$-40^\circ\text{C} \leq T_A \leq +125^\circ\text{C}^1$			17	mA

¹ Full electrical specifications to -55°C , but these package types are guaranteed for operation from -40°C to $+125^\circ\text{C}$ only. Package reliability below -40°C is not guaranteed.

² Guaranteed by design.

AD8564

 $V_{+ANA} = V_{+DIG} = 5.0\text{ V}$, $V_{-ANA} = -5\text{ V}$, $T_A = 25^\circ\text{C}$, unless otherwise noted.

Table 2.

Parameter	Symbol	Conditions	Min	Typ	Max	Unit
INPUT CHARACTERISTICS						
Offset Voltage	V_{OS}	$-40^\circ\text{C} \leq T_A \leq +125^\circ\text{C}^1$		2.3	7	mV
Offset Voltage Drift	$\Delta V_{OS}/\Delta T$			4	10	$\mu\text{V}/^\circ\text{C}$
Input Bias Current	I_B	$V_{CM} = 0\text{ V}$ $-40^\circ\text{C} \leq T_A \leq +125^\circ\text{C}^1$			± 4	μA
Input Offset Current	I_{OS}	$V_{CM} = 0\text{ V}$			± 3	μA
Input Common-Mode Voltage Range	V_{CM}		-4.9		+3.5	V
Common-Mode Rejection Ratio	CMRR	$0\text{ V} \leq V_{CM} \leq 3.0\text{ V}$	65	85		dB
Large Signal Voltage Gain	A_{VO}	$R_L = 10\text{ k}\Omega$		3000		V/V
Input Capacitance	C_{IN}			3.0		pF
DIGITAL OUTPUTS						
Logic 1 Voltage	V_{OH}	$I_{OH} = -3.2\text{ mA}$, $\Delta V_{IN} > +250\text{ mV}$	2.6	3.6		V
Logic 0 Voltage	V_{OL}	$I_{OL} = 3.2\text{ mA}$, $\Delta V_{IN} > 250\text{ mV}$		0.2	0.3	V
DYNAMIC PERFORMANCE²						
Propagation Delay	t_P	200 mV step with 100 mV overdrive $-40^\circ\text{C} \leq T_A \leq +85^\circ\text{C}^1$		6.75	9.8	ns
				8	13	ns
Differential Propagation Delay (Rising Propagation Delay vs. Falling Propagation Delay)	Δt_P	100 mV step with 5 mV overdrive 100 mV step with 20 mV overdrive		8		ns
				0.5	2.0	ns
Rise Time		20% to 80%		3		ns
Fall Time		20% to 80%		3		ns
POWER SUPPLY						
Power Supply Rejection Ratio	PSRR	$4.5\text{ V} \leq V_{+ANA}$ and $V_{+DIG} \leq 5.5\text{ V}$	50	70		dB
Analog Supply Current	I_{+ANA}	$-40^\circ\text{C} \leq T_A \leq +85^\circ\text{C}^1$ $-40^\circ\text{C} \leq T_A \leq +125^\circ\text{C}^1$		10.8	14.0	mA
					15.6	mA
					17	mA
Digital Supply Current	I_{DIG}	$V_O = 0\text{ V}$, $R_L = \infty$ $-40^\circ\text{C} \leq T_A \leq +125^\circ\text{C}^1$		3.6	4.4	mA
					5.6	mA
Analog Supply Current	I_{-ANA}	$-40^\circ\text{C} \leq T_A \leq +85^\circ\text{C}^1$ $-40^\circ\text{C} \leq T_A \leq +125^\circ\text{C}^1$		-8.2	+14.0	mA
					15.6	mA
					17	mA

¹ Full electrical specifications to -55°C , but these package types are guaranteed for operation from -40°C to $+125^\circ\text{C}$ only. Package reliability below -40°C is not guaranteed.

² Guaranteed by design.

ABSOLUTE MAXIMUM RATINGS

Table 3.

Parameter	Rating
Total Analog Supply Voltage	14 V
Digital Supply Voltage	17 V
Analog Positive Supply to Digital Positive Supply	-600 mV
Input Voltage ¹	±7 V
Differential Input Voltage	±8 V
Output Short-Circuit Duration to GND	Indefinite
Storage Temperature Range	-65°C to +150°C
Operating Temperature Range	-55°C to +125°C
Junction Temperature Range	-65°C to +150°C
Lead Temperature Range (Soldering, 10 sec)	300°C

¹ The analog input voltage is equal to ±7 V or the analog supply voltage, whichever is less.

Stresses above those listed under Absolute Maximum Ratings may cause permanent damage to the device. This is a stress rating only; functional operation of the device at these or any other conditions above those indicated in the operational section of this specification is not implied. Exposure to absolute maximum rating conditions for extended periods may affect device reliability.

THERMAL RESISTANCE

θ_{JA} is specified for the worst-case conditions, that is, a device soldered in a circuit board for surface-mount packages (SOIC and TSSOP). θ_{JA} is specified for device in socket for PDIP.

Table 4. Thermal Resistance

Package Type	θ_{JA}	θ_{JC}	Unit
16-Lead PDIP (N)	90	47	°C/W
16-Lead Narrow Body SOIC (R)	113	37	°C/W
16-Lead TSSOP (RU)	180	37	°C/W

ESD CAUTION



ESD (electrostatic discharge) sensitive device. Charged devices and circuit boards can discharge without detection. Although this product features patented or proprietary protection circuitry, damage may occur on devices subjected to high energy ESD. Therefore, proper ESD precautions should be taken to avoid performance degradation or loss of functionality.

AD8564

TYPICAL PERFORMANCE CHARACTERISTICS

$V_{+ANA} = V_{+DIG} = 5\text{ V}$, $V_{-ANA} = 0\text{ V}$, $T_A = 25^\circ\text{C}$, unless otherwise noted.

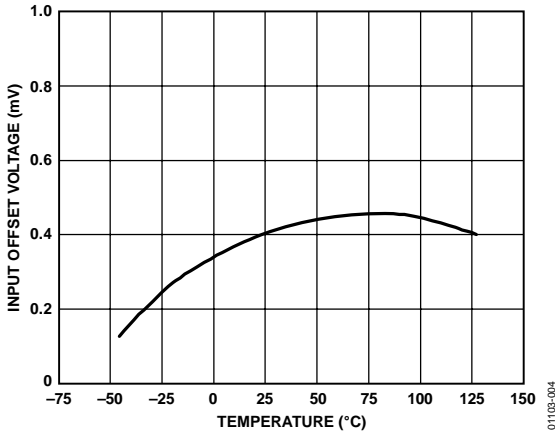

Figure 4. Input Offset Voltage vs. Temperature

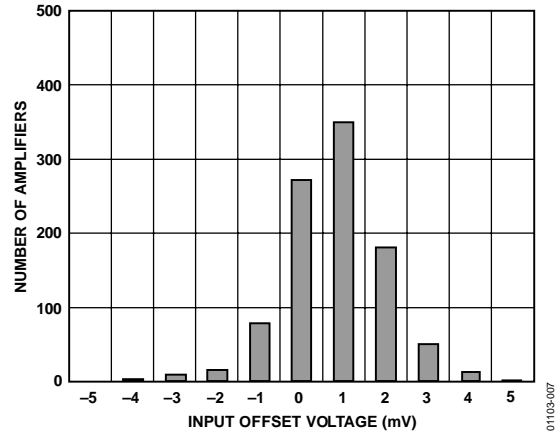

Figure 7. Input Offset Voltage Distribution

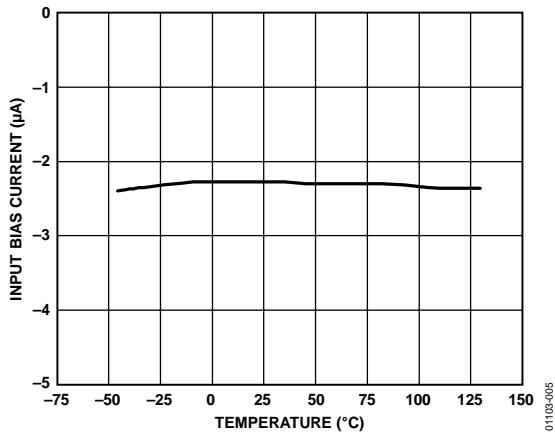

Figure 5. Input Bias Current vs. Temperature

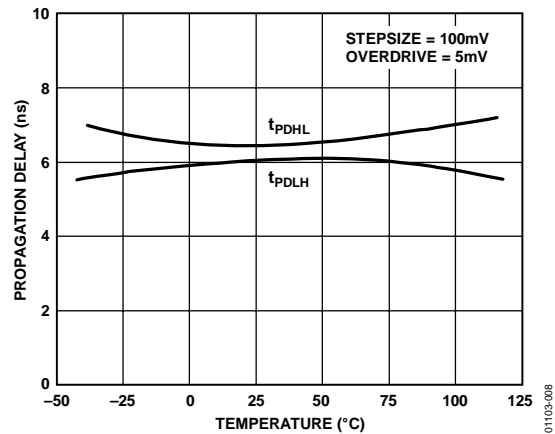

Figure 8. Propagation Delay, t_{PDHL}/t_{PDLH} vs. Temperature

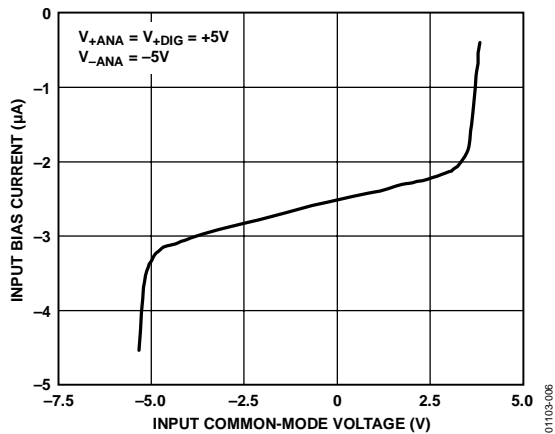

Figure 6. Input Bias Current vs. Input Common-Mode Voltage

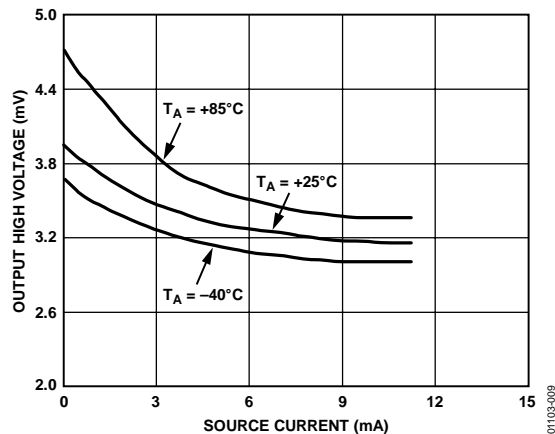

Figure 9. Output High Voltage, V_{OH} vs. Source Current

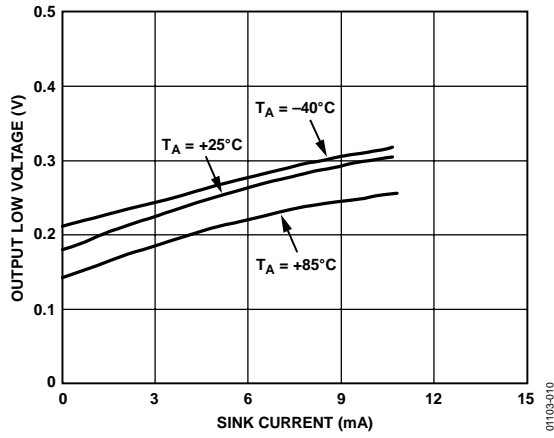

Figure 10. Output Low Voltage, V_{OL} vs. Sink Current

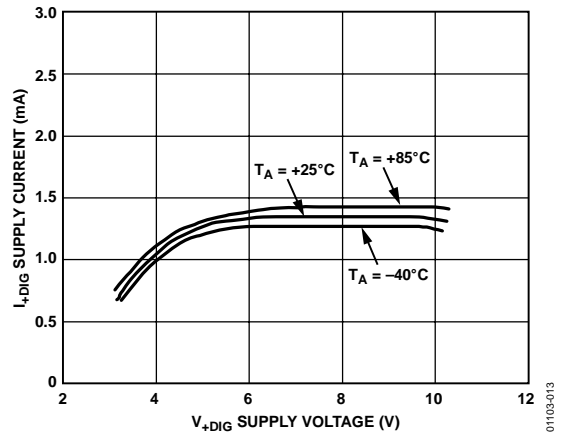

Figure 13. I_{+DIG} Supply Current/Comparator vs. V_{+DIG} Supply Voltage

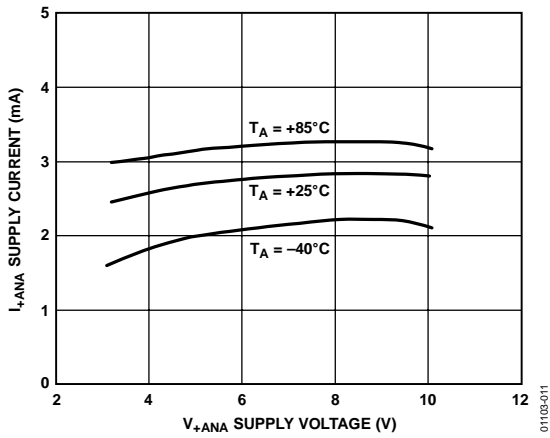

Figure 11. I_{+ANA} Supply Current/Comparator vs. V_{+ANA} Supply Voltage

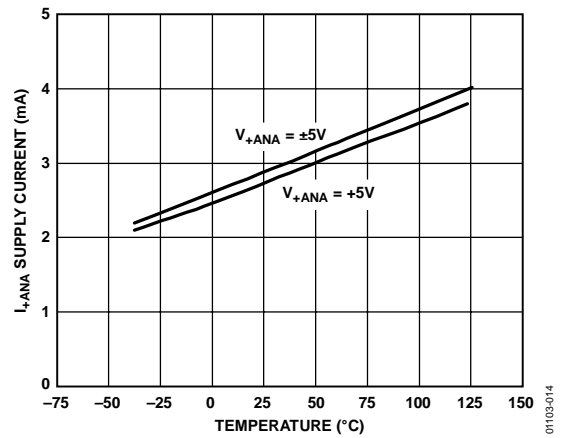

Figure 14. I_{+ANA} Supply Current/Comparator vs. Temperature

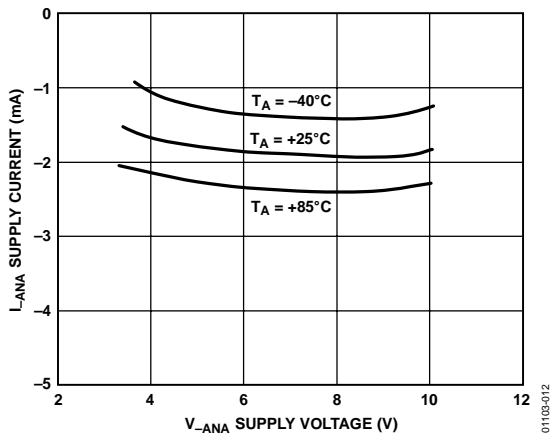

Figure 12. I_{-ANA} Supply Current/Comparator vs. V_{-ANA} Supply Voltage

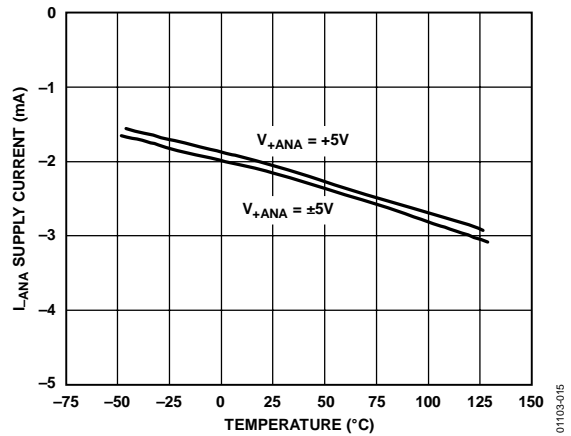

Figure 15. I_{-ANA} Supply Current/Comparator vs. Temperature

AD8564

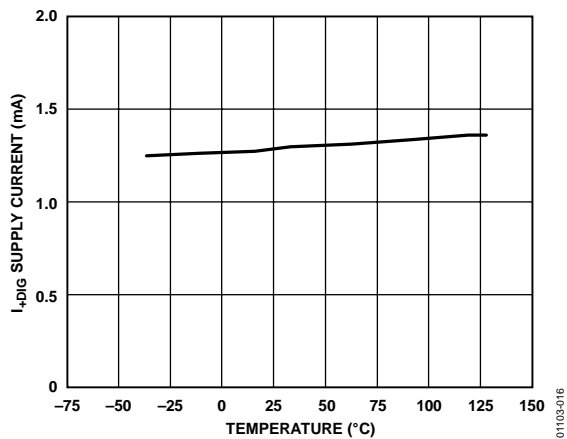

Figure 16. I+DIG Supply Current/Comparator vs. Temperature

01103/016

APPLICATIONS INFORMATION

OPTIMIZING HIGH SPEED PERFORMANCE

As with any high speed comparator or amplifier, proper design and layout techniques should be used to ensure optimal performance from the AD8564. The performance limits of high speed circuitry can easily be a result of stray capacitance, improper ground impedance, or other layout issues.

Minimizing resistance from the source to the input is an important consideration in maximizing the high speed operation of the AD8564. Source resistance, in combination with equivalent input capacitance, may cause a lagged response at the input, thus delaying the output. The input capacitance of the AD8564, in combination with stray capacitance from an input pin to ground, may result in several picofarads of equivalent capacitance. A combination of 3 k Ω source resistance and 5 pF of input capacitance yields a time constant of 15 ns, which is slower than the 5 ns capability of the AD8564. Source impedances should be less than 1 k Ω for the best performance.

It is also important to provide bypass capacitors for the power supply in a high speed application. A 1 μ F electrolytic bypass capacitor should be placed within 0.5 inches of each power supply pin to ground. These capacitors reduce any potential voltage ripples from the power supply. In addition, a 10 nF ceramic capacitor should be placed as close as possible to the power supply pins to ground. These capacitors act as a charge reservoir for the device during high frequency switching.

A ground plane is recommended for proper high speed performance. This can be created by using a continuous conductive plane over the surface of the circuit board, only allowing breaks in the plane for necessary current paths. The ground plane provides a low inductance ground, eliminating any potential differences at different ground points throughout the circuit board caused from ground bounce. A proper ground plane also minimizes the effects of stray capacitance on the circuit board.

OUTPUT LOADING CONSIDERATIONS

The AD8564 output can deliver up to 40 mA of output current without any significant increase in propagation delay. The output of the device should not be connected to more than 20 TTL input logic gates or drive a load resistance less than 100 Ω .

To ensure the best performance from the AD8564, it is important to minimize capacitive loading of the output of the device. Capacitive loads greater than 50 pF cause ringing on the output waveform and reduce the operating bandwidth of the comparator. Propagation delay also increases with capacitive loads above 100 pF.

INPUT STAGE AND BIAS CURRENTS

The AD8564 uses a PNP differential input stage that enables the input common-mode range to extend all the way from the negative supply rail to within 2.2 V of the positive supply rail. The input common-mode voltage can be found as the average of the voltage at the two inputs of the device. To ensure the fastest response time, care should be taken to not allow the input common-mode voltage to exceed this voltage.

The input bias current for the AD8564 is 4 μ A. As with any PNP differential input stage, this bias current goes to 0 on an input that is high and doubles on an input that is low. Care should be taken in choosing resistor values to be connected to the inputs because large resistors could cause significant voltage drops due to the input bias current.

The input capacitance for the AD8564 is typically 3 pF. This can be measured by inserting a large source resistance to the input and measuring the change in propagation delay.

AD8564

USING HYSTERESIS

Hysteresis can easily be added to a comparator through the addition of positive feedback. Adding hysteresis to a comparator offers an advantage in noisy environments where it is not desirable for the output to toggle between states when the input signal is near the switching threshold. Figure 17 shows a method for configuring the AD8564 with hysteresis.

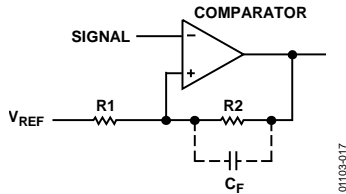

Figure 17. Configuring the AD8564 with Hysteresis

The input signal is connected directly to the inverting input of the comparator. The output is fed back to the noninverting input through R2 and R1. The ratio of R1 to R1 + R2 and the output swing establishes the width of the hysteresis window, with V_{REF} setting the center of the window or the average switching voltage. The output switches high when the input

voltage is greater than V_{HI} and does not switch low again until the input voltage is less than V_{LO}, as given in Equation 2.

$$V_{HI} = \left(V_+ - 1 - V_{REF} \right) \frac{R1}{R1 + R2} V_{REF} \quad (1)$$

$$V_{LO} = V_{REF} \left(1 - \frac{R1}{R1 + R2} \right) \quad (2)$$

where V₊ is the positive supply voltage.

The C_F capacitor may also be added to introduce a pole into the feedback network. This has the effect of increasing the amount of hysteresis at high frequencies. This can be useful when comparing a relatively slow signal in a high frequency noise environment.

At frequencies greater than $f_p = \frac{1}{2\pi C_f R2}$, the hysteresis window approaches V_{HI} = V₊ - 1 V and V_{LO} = 0 V.

At frequencies less than f_p, the threshold voltages remain as it is in Equation 1.

OUTLINE DIMENSIONS

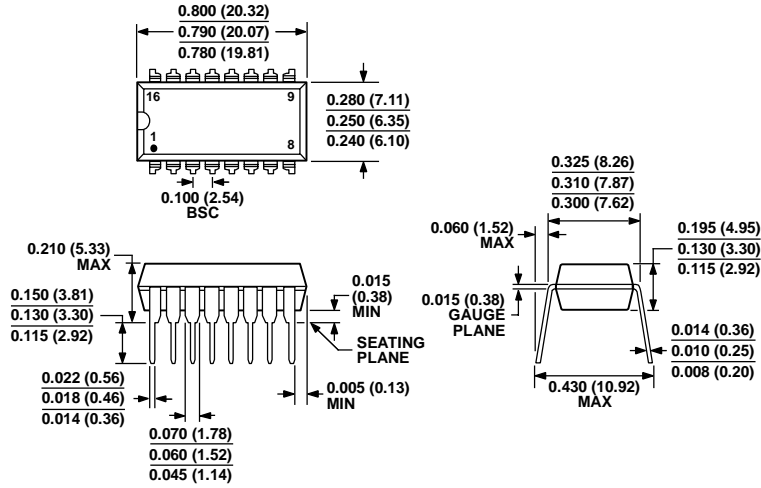

COMPLIANT TO JEDEC STANDARDS MS-001-AB
 CONTROLLING DIMENSIONS ARE IN INCHES; MILLIMETER DIMENSIONS (IN PARENTHESES) ARE ROUNDED-OFF INCH EQUIVALENTS FOR REFERENCE ONLY AND ARE NOT APPROPRIATE FOR USE IN DESIGN. CORNER LEADS MAY BE CONFIGURED AS WHOLE OR HALF LEADS.

Figure 18. 16-Lead Plastic Dual In-Line Package [PDIP] (N-16)

Dimensions shown in inches and (millimeters)

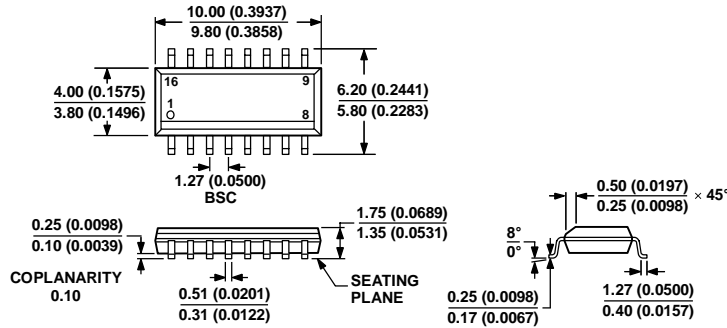

COMPLIANT TO JEDEC STANDARDS MS-012-AC
 CONTROLLING DIMENSIONS ARE IN MILLIMETERS; INCH DIMENSIONS (IN PARENTHESES) ARE ROUNDED-OFF MILLIMETER EQUIVALENTS FOR REFERENCE ONLY AND ARE NOT APPROPRIATE FOR USE IN DESIGN.

Figure 19. 16-Lead Standard Small Outline Package [SOIC_N]

Narrow Body

(R-16)

Dimensions shown in millimeters and (inches)

AD8564

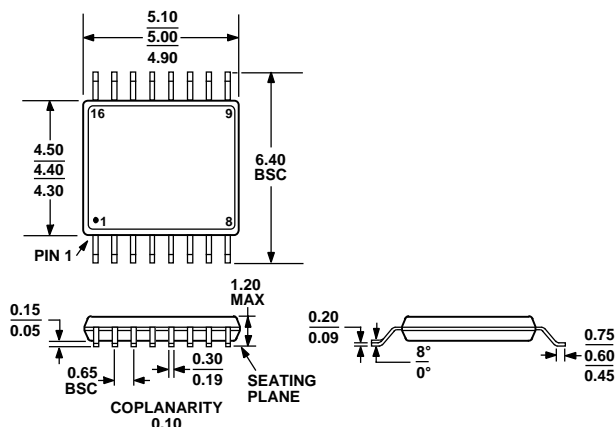

COMPLIANT TO JEDEC STANDARDS MO-153-AB

Figure 20. 16-Lead Thin Shrink Small Outline Package [TSSOP]
 (RU-16)

Dimensions shown in millimeters

ORDERING GUIDE

Model	Temperature Range	Package Description	Package Option
AD8564AN	-40°C to +125°C	16-Lead Plastic Dual In-Line Package [PDIP]	N-16
AD8564ANZ ¹	-40°C to +125°C	16-Lead Plastic Dual In-Line Package [PDIP]	N-16
AD8564AR	-40°C to +125°C	16-Lead Standard Small Outline Package [SOIC_N]	R-16
AD8564AR-REEL	-40°C to +125°C	16-Lead Standard Small Outline Package [SOIC_N]	R-16
AD8564AR-REEL7	-40°C to +125°C	16-Lead Standard Small Outline Package [SOIC_N]	R-16
AD8564ARZ ¹	-40°C to +125°C	16-Lead Standard Small Outline Package [SOIC_N]	R-16
AD8564ARZ-REEL ¹	-40°C to +125°C	16-Lead Standard Small Outline Package [SOIC_N]	R-16
AD8564ARZ-REEL7 ¹	-40°C to +125°C	16-Lead Standard Small Outline Package [SOIC_N]	R-16
AD8564ARU-REEL	-40°C to +125°C	16-Lead Thin Shrink Small Outline Package [TSSOP]	RU-16
AD8564ARUZ-REEL ¹	-40°C to +125°C	16-Lead Thin Shrink Small Outline Package [TSSOP]	RU-16

¹ Z = RoHS Compliant Part.