

## Excellent Integrated System Limited

Stocking Distributor

Click to view price, real time Inventory, Delivery & Lifecycle Information:

[Analog Devices Inc.](#)  
[ADM8828ART-REEL](#)

For any questions, you can email us directly:

[sales@integrated-circuit.com](mailto:sales@integrated-circuit.com)



# Switched-Capacitor Voltage Inverter with Shutdown

## ADM8828/ADM8829

### FEATURES

- Inverts Input Supply Voltage
- 99% Voltage Conversion Efficiency
- 25 mA Output Current
- Shutdown Function
- Requires Only Two Capacitors
- 1  $\mu$ F Capacitors
- 18  $\Omega$  Output Resistance
- +1.5 V to +5.5 V Input Range
- 600  $\mu$ A Quiescent Current
- 20 nA Shutdown Current (ADM8828)

### APPLICATIONS

- Handheld Instruments
- LCD Panels
- Cellular Phones
- PDA's
- Remote Data Acquisition
- Op Amp Power Supplies

### FUNCTIONAL BLOCK DIAGRAMS

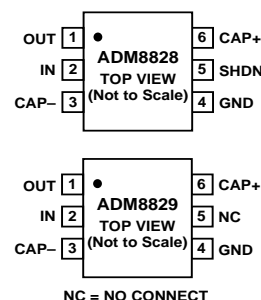

### GENERAL DESCRIPTION

The ADM8828/ADM8829 is a charge-pump voltage inverter which may be used to generate a negative supply from a positive input. Input voltages ranging from +1.5 V to +5.5 V can be inverted into a negative -1.5 V to -5.5 V output supply. This inverting scheme is ideal for generating a negative rail in single power-supply systems. Only two small external capacitors are needed for the charge pump. Output currents up to 25 mA with greater than 99% efficiency are achievable.

The ADM8828 also features a low power shutdown (SHDN) pin. This can be used to disable the device and reduce the quiescent current to 20 nA.

The ADM8828/ADM8829 is available in a 6-lead SOT-23 package.

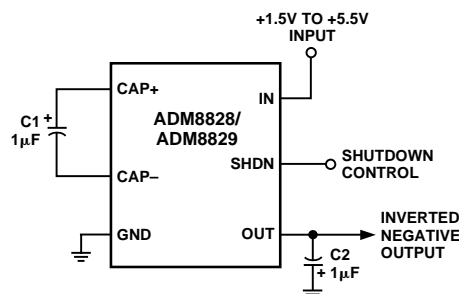

Figure 1. Typical Circuit Configuration

### REV. A

Information furnished by Analog Devices is believed to be accurate and reliable. However, no responsibility is assumed by Analog Devices for its use, nor for any infringements of patents or other rights of third parties which may result from its use. No license is granted by implication or otherwise under any patent or patent rights of Analog Devices.

# ADM8828/ADM8829—SPECIFICATIONS ( $V_{IN} = +5\text{ V}$ , $C1, C2 = 1\ \mu\text{F}$ ,<sup>1</sup> $T_A = T_{MIN}$ to $T_{MAX}$ unless otherwise noted)

Parameter	Min	Typ	Max	Units	Test Conditions/Comments
Input Voltage, IN	1.5		5.5	V	$R_L = 10\ \text{k}\Omega$
Supply Current		600	1000	$\mu\text{A}$	Unloaded
Output Current	25			mA	
Output Resistance		18	28	$\Omega$	$I_L = 5\ \text{mA}$
Output Ripple		25		mV p-p	$I_L = 5\ \text{mA}$
		130		mV p-p	$I_L = 25\ \text{mA}$
Charge-Pump Frequency	50	120	190	kHz	
	65			kHz	$V_{IN} = +2.25\ \text{V}$
Power Efficiency		90		%	$R_L = 200\ \Omega$
		87		%	$R_L = 1\ \text{k}\Omega$
Voltage Conversion Efficiency	99.5	99.96		%	No Load
		98		%	$R_L = 1\ \text{k}\Omega$
		91		%	$R_L = 200\ \Omega$
Shutdown Supply Current, $I_{SHDN}$		0.02	2	$\mu\text{A}$	SHDN = IN
Shutdown Input Voltage, $V_{SHDN}$	2.0		0.8	V	SHDN High = Disabled
				V	SHDN Low = Enabled
Shutdown Exit Time		175		$\mu\text{s}$	$I_L = 5\ \text{mA}$

## NOTES

<sup>1</sup>C1 and C2 are low ESR (<0.2  $\Omega$ ) electrolytic capacitors. High ESR will degrade performance.  
 Specifications subject to change without notice.

## ABSOLUTE MAXIMUM RATINGS\*

( $T_A = +25^\circ\text{C}$  unless otherwise noted)

Input Voltage (IN to GND)	-0.3 V to +6 V
OUT to GND	-6.0 V to +0.3 V
OUT, IN Output Current (Continuous)	50 mA
Output Short Circuit Duration to GND	10 secs
Power Dissipation, RT-6	570 mW
(Derate 8.3 mW/ $^\circ\text{C}$ above +70 $^\circ\text{C}$ )	
$\theta_{JA}$ , Thermal Impedance	120 $^\circ\text{C}/\text{W}$
Operating Temperature Range	
Industrial (A Version)	-40 $^\circ\text{C}$ to +85 $^\circ\text{C}$
Storage Temperature Range	-65 $^\circ\text{C}$ to +150 $^\circ\text{C}$
Lead Temperature Range (Soldering 10 sec)	+300 $^\circ\text{C}$
Vapor Phase (70 sec)	+215 $^\circ\text{C}$
Infrared (15 sec)	+220 $^\circ\text{C}$
ESD Rating	>3500 V

\*This is a stress rating only and functional operation of the device at these or any other conditions above those indicated in the operation section of this specification is not implied. Exposure to absolute maximum rating conditions for extended periods may affect device reliability.

## ORDERING GUIDE

Model	Temperature Range	Branding Information	Package Option*
ADM8828ART	-40 $^\circ\text{C}$ to +85 $^\circ\text{C}$	MM0	RT-6
ADM8829ART	-40 $^\circ\text{C}$ to +85 $^\circ\text{C}$	MN0	RT-6

\*RT-6 = 6-lead SOT-23.

## PIN FUNCTION DESCRIPTIONS

Mnemonic	Function
CAP+	Positive Charge-Pump Capacitor Terminal.
GND	Power Supply Ground.
CAP-	Negative Charge-Pump Capacitor Terminal.
OUT	Output, Negative Voltage.
SHDN	Shutdown Control Input. This input, when high, is used to disable the charge pump thereby reducing the power consumption.
IN	Positive Power Supply Input.

## PIN CONFIGURATIONS

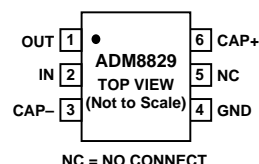
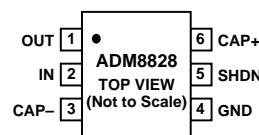

## Typical Performance Characteristics—ADM8828/ADM8829

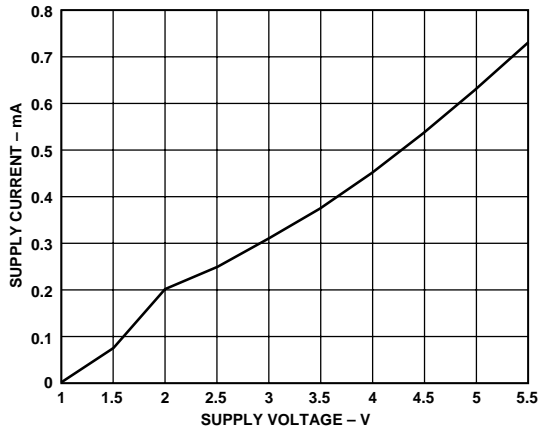

Figure 2. Power Supply Current vs. Voltage

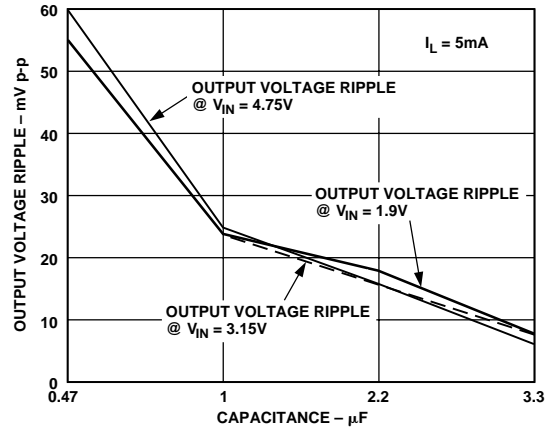

Figure 5. Output Voltage Ripple vs. Capacitance

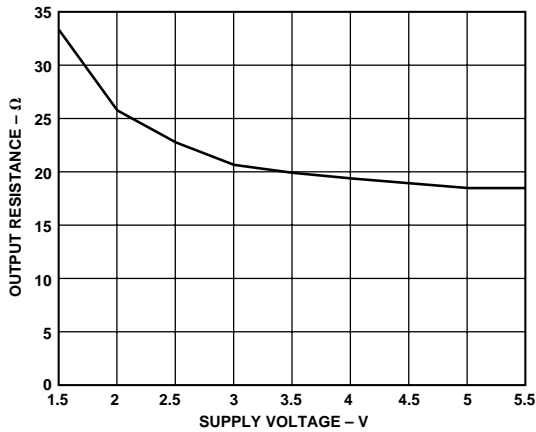

Figure 3. Output Source Resistance vs. Supply Voltage

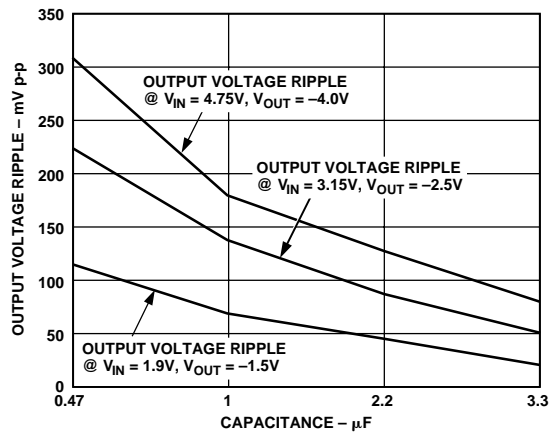

Figure 6. Output Voltage Ripple vs. Capacitance

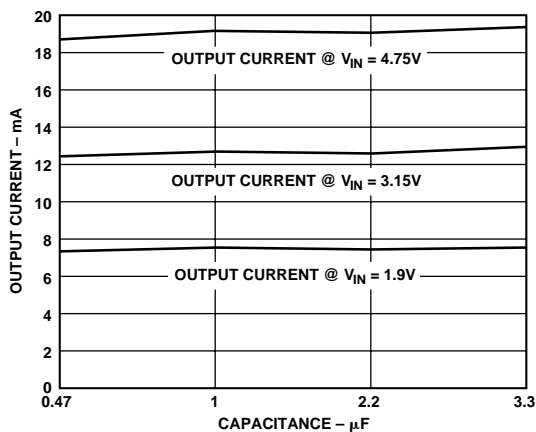

Figure 4. Output Current vs. Capacitance

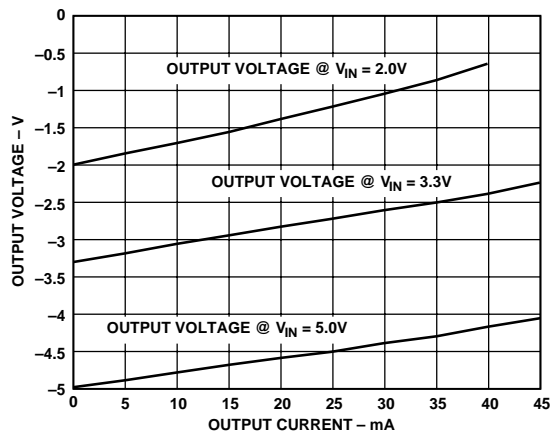

Figure 7. Output Voltage vs. Output Current

## ADM8828/ADM8829

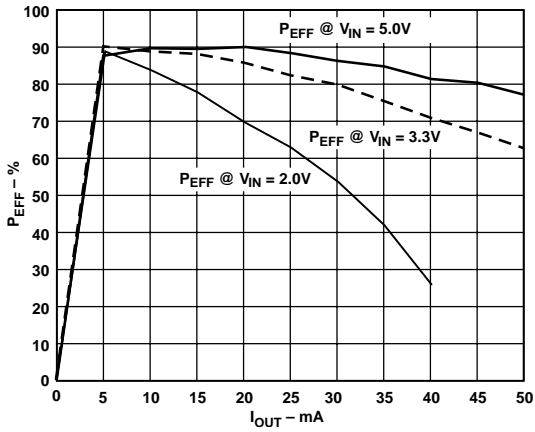

Figure 8. Power Efficiency vs. Output Current

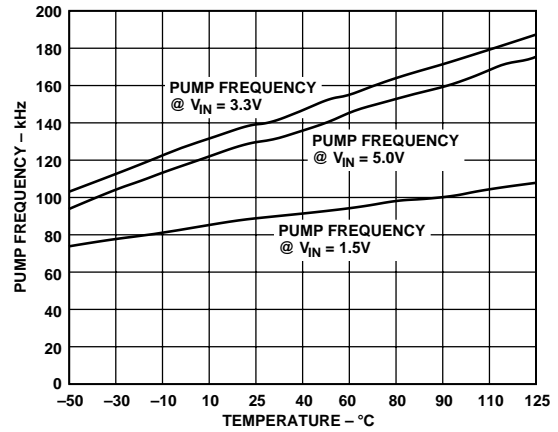

Figure 10. Charge Pump Frequency vs. Temperature

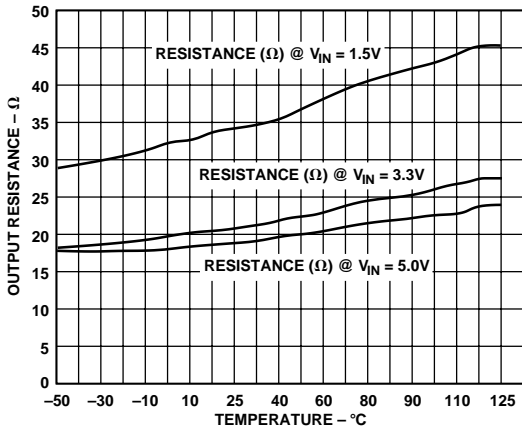

Figure 9. Output Resistance vs. Temperature

## ADM8828/ADM8829

### GENERAL INFORMATION

The ADM8828/ADM8829 is a switched capacitor voltage converter that can be used to invert the input supply voltage.

The voltage conversion task is achieved using a switched capacitor technique using two external charge storage capacitors. An on-chip oscillator and switching network transfers charge between the charge storage capacitors. The basic principle behind the voltage conversion scheme is illustrated below.

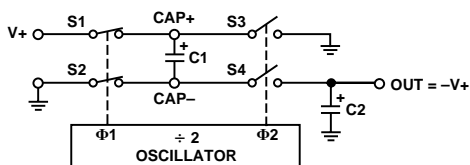

Figure 11. Voltage Inversion Principle

An oscillator generating antiphase signals  $\phi 1$  and  $\phi 2$  controls switches S1, S2 and S3, S4. During  $\phi 1$ , switches S1 and S2 are closed while S3 and S4 are open, thereby charging C1 up to the voltage at  $V+$ . During  $\phi 2$ , S1 and S2 open and S3 and S4 close. The positive terminal of C1 is connected to GND via S3 during this phase and the negative terminal of C1 connects to  $V_{OUT}$  via S4. The net result is voltage inversion at  $V_{OUT}$  wrt GND. Charge on C1 is transferred to C2 during  $\phi 2$ . Capacitor C2 maintains this voltage during  $\phi 1$ . The charge transfer efficiency depends on the on-resistance of the switches, the frequency at which they are being switched and also on the equivalent series resistance (ESR) of the external capacitors. For maximum efficiency, capacitors with low ESR are, therefore, recommended.

### Shutdown Input

The ADM8828 contains a shutdown input that can be used to disable the device and hence reduce the power consumption. A logic high level on the SHDN input shuts the device down reducing the quiescent current to  $0.02 \mu A$ . During shutdown the output voltage discharges to 0 V. Therefore, ground referenced loads are not powered during this state. When exiting shutdown, it takes several cycles (approximately  $175 \mu s$ ) for the charge pump to reach its final value. If the shutdown function is not being used, SHDN should be hardwired to GND.

### Capacitor Selection

The flying capacitor C1 can be increased to reduce the output resistance.

The output capacitor size C2 affects the output ripple. Increasing the capacitor size reduces the peak-peak ripple. The ESR affects both the output impedance and the output ripple.

Reducing the ESR reduces the output impedance and ripple. For convenience it is recommended that both C1 and C2 be the same value.

The ac impedance of the ADM8828/ADM8829 may be reduced by using a bypass capacitor on the input supply. This capacitor should be connected between the input supply and GND. It will provide instantaneous current surges as required. Suitable capacitors of  $1 \mu F$  or greater may be used.

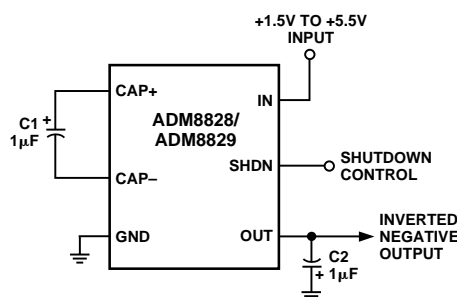

Figure 12. Typical Circuit Configuration

# ADM8828/ADM8829

## OUTLINE DIMENSIONS

Dimensions shown in inches and (mm).

### 6-Lead SOT-23 (RT-6)

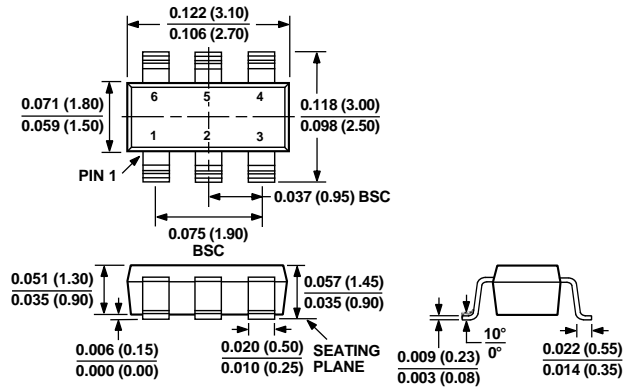

C3352a-0-10/99

PRINTED IN U.S.A.