

Excellent Integrated System Limited

Stocking Distributor

Click to view price, real time Inventory, Delivery & Lifecycle Information:

[Panasonic Electric Works](#)
[AQE12105](#)

For any questions, you can email us directly:

sales@integrated-circuit.com

Panasonic
ideas for life

**1A AC and 3A DC
space saving
PC board terminal type**

AQ-E RELAYS

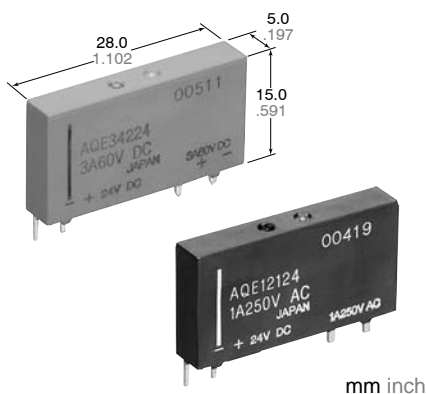

FEATURES

- 1. Conforms to European safety standards (VDE0110)**
dielectric distance between input and output
 - Creepage distance: Min. 3.0 mm
 - Clearances distance: Min. 2.5 mm
- 2. The small-sized vertical type**
28 mm (L)×5 mm (W)×15 mm
1.063 inch (L)×.197 inch (W)×.591 inch
permits high density mounting to PC board
- 3. High dielectric strength: 2,500V AC**
(between input and output)

- 4. Two load types available:**
DC output type (3A)
AC output type (1A)
- 5. Zero-cross type are available (AC type)**
The zero-cross type generates minimal noise
- 6. Snubber circuit integrated (AC type)**
The snubber circuit is integrated to prevent malfunction caused by the rapid rise of voltage on the output side, such as inductive load and current.

TYPES

Type	Load voltage	Input voltage	Part No.
AC output	75 to 250 V AC	5 V DC	AQE12105
		12 V DC	AQE12112
		24 V DC	AQE12124
DC output	3 to 60 V DC	5 V DC	AQE34205
		12 V DC	AQE34212
		24 V DC	AQE34224

TYPICAL APPLICATIONS

- Interface relays for programmable controllers
- Industrial equipment
- Timers and counters
- Air conditioners

ORDERING INFORMATION

Ex. AQE 1 2 1 0 5

Load current	Load voltage	Type	Input voltage
1: 1 A 3: 3 A	2: 75 to 250 V AC 4: 3 to 60 V DC	1: AC output (Zero-cross) 2: DC output	05: 5 V DC 12: 12 V DC 24: 24 V DC

(Note) Standard packing: Carton 20 pcs., Case 1,000 pcs.

AQ-E

SPECIFICATIONS

Ratings (at 20°C 68°F, Input voltage ripple: 1% or less)

Item	Type	AC output			DC output			Remarks
	Part No.	AQE12105	AQE12112	AQE12124	AQE34205	AQE34212	AQE34224	
Input side	Input voltage	4 to 6 V DC	9.6 to 14.4 V DC	21.6 to 26.4 V DC	4 to 6 V DC	9.6 to 14.4 V DC	21.6 to 26.4 V DC	
	Input impedance	Approx. 0.5k Ω	Approx. 1.3k Ω	Approx. 3k Ω	Approx. 0.5k Ω	Approx. 1.3k Ω	Approx. 3k Ω	
	Drop-out voltage, min.	0.5 V DC	1.2 V DC	2.4 V DC	0.5 V DC	1.2 V DC	2.4 V DC	
	Reverse voltage	3 V						
Load side	Max. load current	1 A AC			3 A DC			
	Load voltage	75 to 250 V AC			3 to 60 V DC			
	Frequency	45 to 65 Hz			—			
	Non-repetitive surge current	20 A			15 A			AC: In one cycle at 60 Hz DC: 10 ms
	Max. "OFF-state" leakage current	1.5 mA (applied 200 V)			10μA			
	Max. "ON-state" voltage drop	1.6 V			0.3 V			at Max. carrying current
	Min. load current	20 mA			1 mA			
	OFF state dV/dt	50 V/μs			—			
Max. operating speed	—			0.5cps.			at rated operating voltage, rated load voltage and current	

Characteristics (at 20°C 68°F, Input voltage ripple: 1% or less)

Item	AC output	DC output	Remarks
Operate time max.	(1/2 cycle of voltage sine wave) + 1 ms	2 ms	
Release time, max.	(1/2 cycle of voltage sine wave) + 1 ms	0.4 ms	
Insulation resistance, min.	10 ⁹ Ω between input and output		Using 500 V DC megger
Breakdown voltage	2,500 Vrms between input and output		Initial for 1 min.
Vibration resistance	Functional	10 to 55 Hz double amplitude of 1.5 mm	
	Destructive	10 to 55 Hz double amplitude of 1.5 mm	
Shock resistance	Functional	Min. 490 m/s ² {50 G}	
	Destructive	Min. 490 m/s ² {50 G}	
Ambient temperature	-30°C to +80°C -22°F to +176°F		
Storage temperature	-30°C to +100°C -22°F to +212°F		
Operational method	Zero-cross (Turn-ON and Turn-OFF)	—	

DIMENSIONS

mm inch

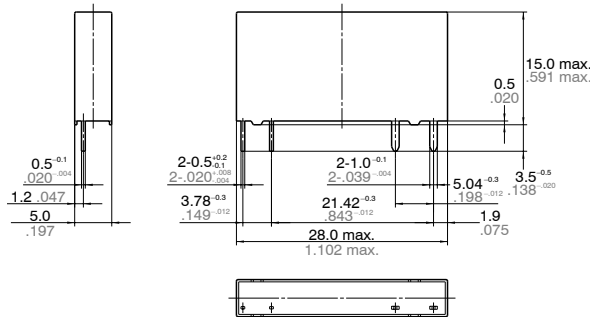

General tolerance: ±0.5 ±.020

Mounting hole location (Bottom view)

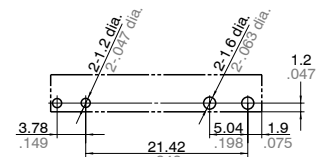

Tolerance: ±0.1 ±.004

Schematic AC type



DC type



REFERENCE DATA

1. Load current vs. ambient temperature

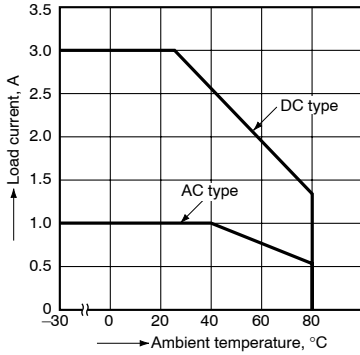

2.-(1) Non-repetitive surge current vs. carrying time (AC output)

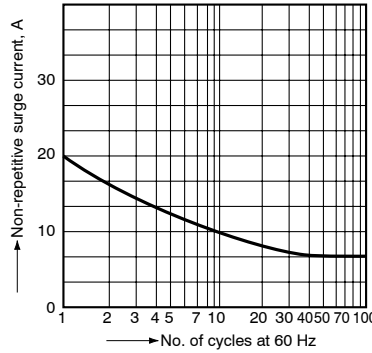

2.-(2) Non-repetitive surge current vs. carrying time (DC output)

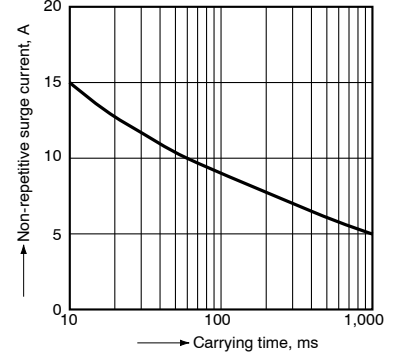

3. Input current vs. input voltage characteristics

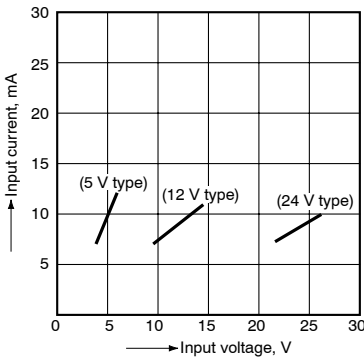

4.-(1) Load current vs. ambient temperature characteristics for adjacent mounting (AC output)

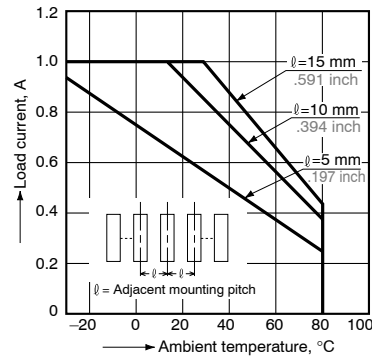

4.-(2) Load current vs. ambient temperature characteristics for adjacent mounting (DC output)

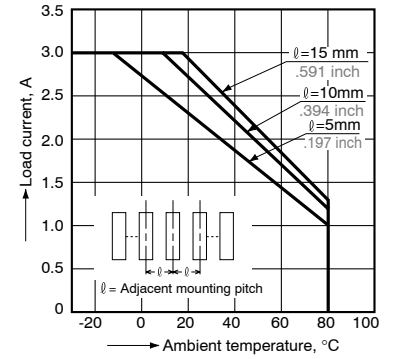

Cautions for Use