

Excellent Integrated System Limited

Stocking Distributor

Click to view price, real time Inventory, Delivery & Lifecycle Information:

[Rohm Semiconductor](#)
[2SD1867TV2](#)

For any questions, you can email us directly:

sales@integrated-circuit.com

2SD2195 / 2SD1980 / 2SD1867

Transistors

Power Transistor (100V, 2A)
2SD2195 / 2SD1980 / 2SD1867

●Features

- 1) Darlington connection for high DC current gain.
- 2) Built-in resistor between base and emitter.
- 3) Built-in damper diode.
- 4) Complements the 2SB1580 / 2SB1316.

●Equivalent circuit

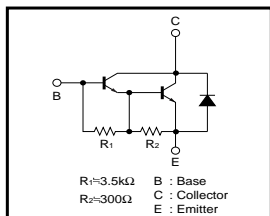

●Absolute maximum ratings (Ta=25°C)

Parameter	Symbol	Limits	Unit
Collector-base voltage	VCBO	100	V
Collector-emitter voltage	VCEO	100	V
Emitter-base voltage	VEBO	6	V
Collector current	IC	2	A(DC)
		3 *1	A(Pulse)
Collector power dissipation	PC	0.5	W
		2 *2	
		1	W(Tc=25°C)
		10	
2SD1867	1 *3	W	
Junction temperature	Tj	150	°C
Storage temperature	Tstg	-55 to +150	°C

*1 Single pulse Pw=100ms
 *2 When mounted on a 40 x 40 x 0.7 mm ceramic board.
 *3 Printed circuit board, 1.7mm thick, collector plating 100mm² or larger.

●External dimensions (Unit : mm)

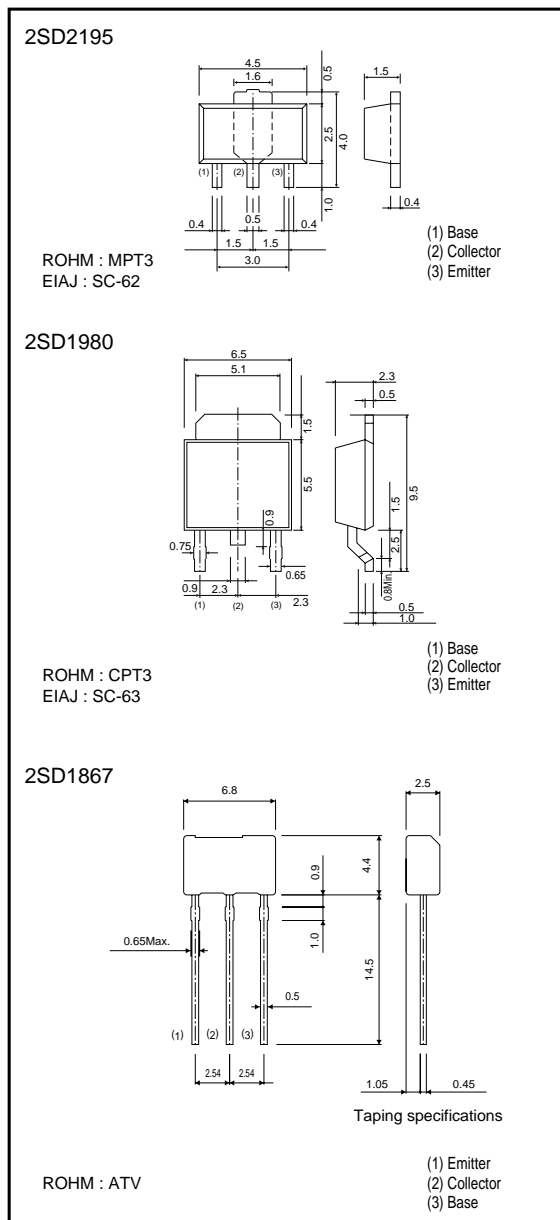

2SD2195 / 2SD1980 / 2SD1867

Transistors

●Packaging specifications and hFE

Type	2SD2195	2SD1980	2SD1867
Package	MPT3	CPT3	ATV
hFE	1k to 10k	1k to 10k	1k to 10k
Marking	DP	-	-
Code	T100	TL	TV2
Basic ordering unit (pieces)	1000	2500	2500

* Denotes hFE

●Electrical characteristics (Ta=25°C)

Parameter	Symbol	Min.	Typ.	Max.	Unit	Conditions
Collector-base breakdown voltage	BVCBO	100	-	-	V	Ic = 50μA
Collector-emitter breakdown voltage	BVCEO	100	-	-	V	Ic = 5mA
Emitter-base breakdown voltage	BVEBO	6	-	-	V	Ie = 5mA
Collector cutoff current	Icbo	-	-	10	μA	Vcb = 100V
Emitter cutoff current	Iebo	-	-	3	mA	VEB = 5V
Collector-emitter saturation voltage	VCE(sat)	-	-	1.5	V	Ic = 1A, Ie = 1mA *
Base-emitter saturation voltage	VBE(sat)	-	-	2.0	V	Ic/Ie = 1A/1mA
DC current transfer ratio	hFE	1000	-	10000	-	VCE = 2V, Ic = 1A *
Transition frequency	fr	-	80	-	MHz	VCE = 5V, Ie = -0.1A, f = 30MHz
Output capacitance	Cob	-	25	-	pF	Vcb = 10V, Ie = 0A, f = 1MHz

* Measured using pulse current.

●Electrical characteristic curves

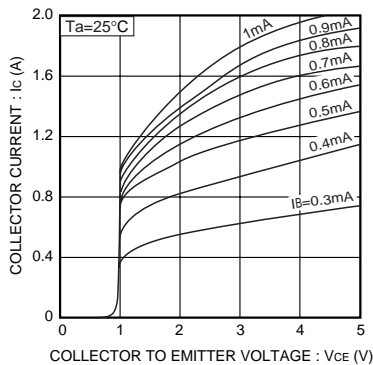

Fig.1 Grounded emitter output characteristics

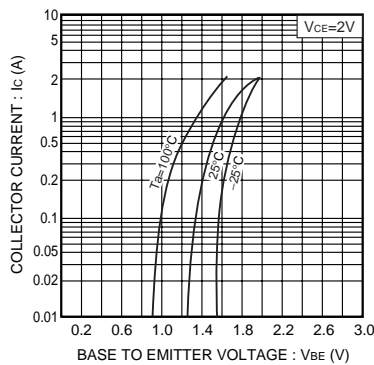

Fig.2 Grounded emitter propagation characteristics

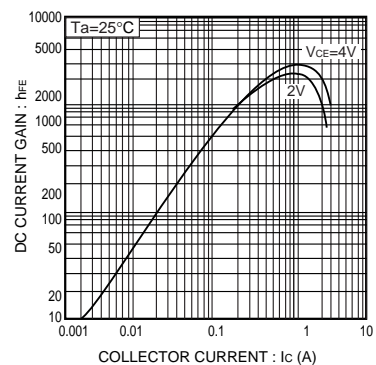

Fig.3 DC current gain vs. collector current

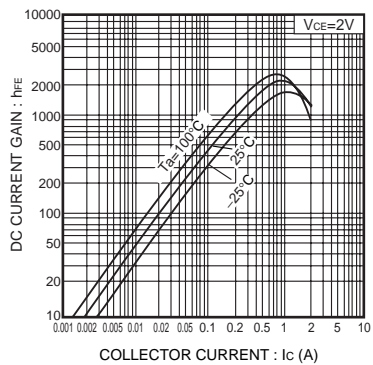

Fig.4 DC current gain vs. collector current

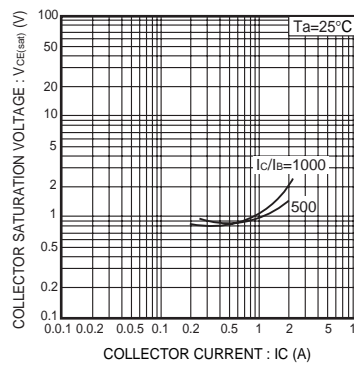

Fig.5 Collector-emitter saturation voltage vs. collector current

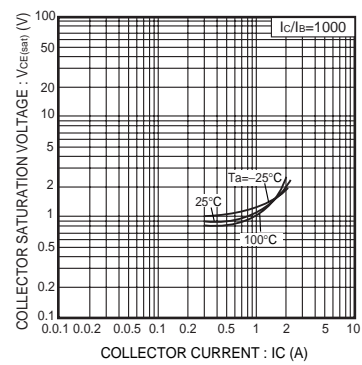

Fig.6 Collector-emitter saturation voltage vs. collector current

2SD2195 / 2SD1980 / 2SD1867

Transistors

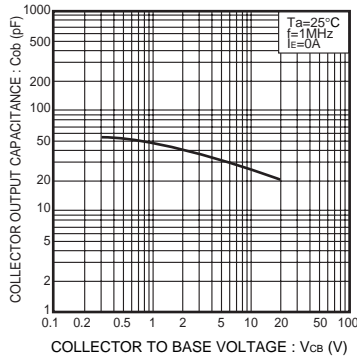

Fig.7 Collector output capacitance vs. collector-base voltage

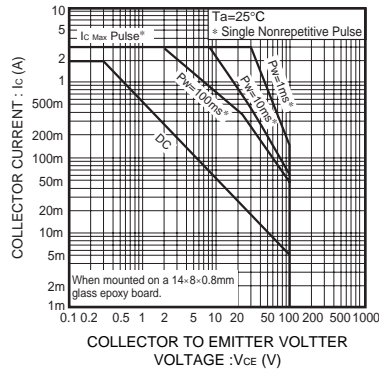

Fig.8 Safe operating area (2SD2195)

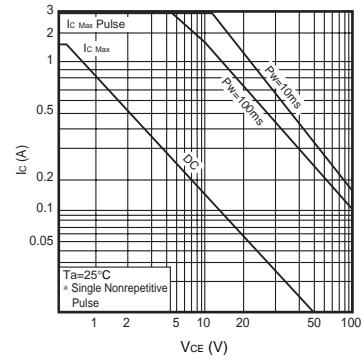

Fig.9 Safe operating area(2SD1867)

Appendix

Notes

- No technical content pages of this document may be reproduced in any form or transmitted by any means without prior permission of ROHM CO.,LTD.
- The contents described herein are subject to change without notice. The specifications for the product described in this document are for reference only. Upon actual use, therefore, please request that specifications to be separately delivered.
- Application circuit diagrams and circuit constants contained herein are shown as examples of standard use and operation. Please pay careful attention to the peripheral conditions when designing circuits and deciding upon circuit constants in the set.
- Any data, including, but not limited to application circuit diagrams information, described herein are intended only as illustrations of such devices and not as the specifications for such devices. ROHM CO.,LTD. disclaims any warranty that any use of such devices shall be free from infringement of any third party's intellectual property rights or other proprietary rights, and further, assumes no liability of whatsoever nature in the event of any such infringement, or arising from or connected with or related to the use of such devices.
- Upon the sale of any such devices, other than for buyer's right to use such devices itself, resell or otherwise dispose of the same, no express or implied right or license to practice or commercially exploit any intellectual property rights or other proprietary rights owned or controlled by
- ROHM CO., LTD. is granted to any such buyer.
- Products listed in this document are no antiradiation design.

The products listed in this document are designed to be used with ordinary electronic equipment or devices (such as audio visual equipment, office-automation equipment, communications devices, electrical appliances and electronic toys).

Should you intend to use these products with equipment or devices which require an extremely high level of reliability and the malfunction of which would directly endanger human life (such as medical instruments, transportation equipment, aerospace machinery, nuclear-reactor controllers, fuel controllers and other safety devices), please be sure to consult with our sales representative in advance.

About Export Control Order in Japan

Products described herein are the objects of controlled goods in Annex 1 (Item 16) of Export Trade Control Order in Japan.

In case of export from Japan, please confirm if it applies to "objective" criteria or an "informed" (by MITI clause) on the basis of "catch all controls for Non-Proliferation of Weapons of Mass Destruction.