

Excellent Integrated System Limited

Stocking Distributor

Click to view price, real time Inventory, Delivery & Lifecycle Information:

[Rohm Semiconductor](#)
[BA15218](#)

For any questions, you can email us directly:

sales@integrated-circuit.com

Standard ICs

Dual high slew rate, low noise operational amplifier

BA15218 / BA15218F / BA15218N

The BA15218, BA15218F, and BA15218N are monolithic ICs with two built-in low-noise, low-distortion operational amplifiers featuring internal phase compensation.

Either a dual or single power supply can be driven, and these products can be driven by a digital system 5V single power supply.

The following packages are available: 8-pin DIP (BA15218), 8-pin SOP (BA15218F), and 8-pin SIP (BA15218N).

●Features

- 1) Low-voltage operation and single power supply drive enabled.
(Single power supply: 4 to 32V, dual power supply: ± 3 to ± 16 V)
- 2) Low noise level. ($V_n = 1.0\mu V_{rms}$ typ. : RIAA)
- 3) High slew rate. ($SR = 3V / \mu s$, $GBW = 10MHz$ typ.)
- 4) Low offset voltage. ($V_{IO} = 0.5mV$ typ.)
- 5) High gain and low distortion. ($G_{VO} = 110dB$, $THD = 0.0015\%$)
- 6) Pin connections are the same as with standard dual operational amplifiers, and outstanding characteristics make these products compatible with the 4558 and 4560 models.

●Block diagram

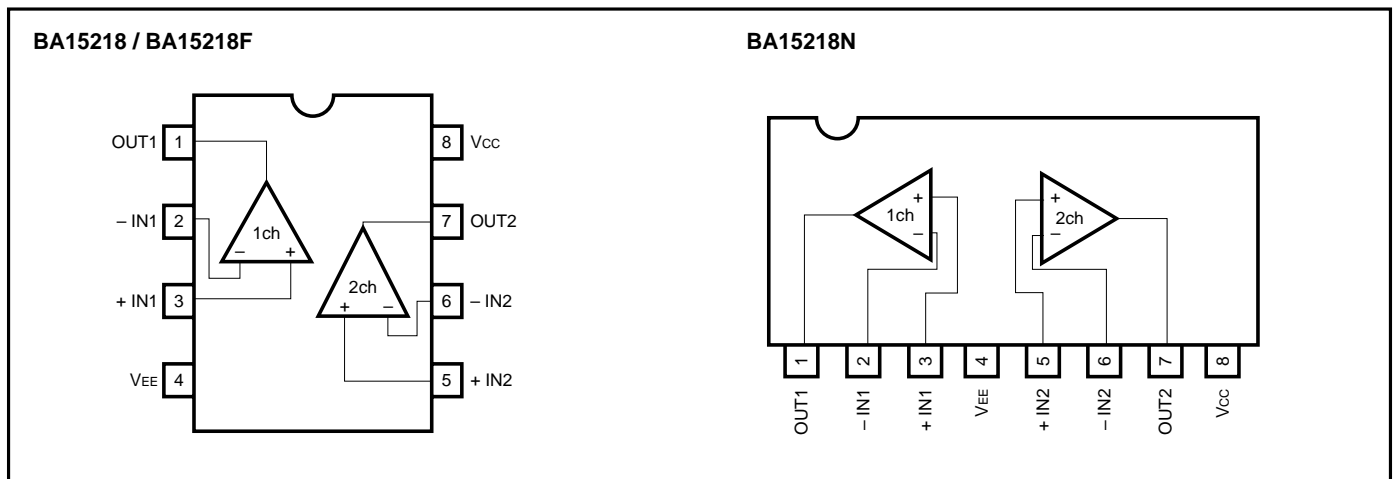

Standard ICs

BA15218 / BA15218F / BA15218N

● Internal circuit configuration

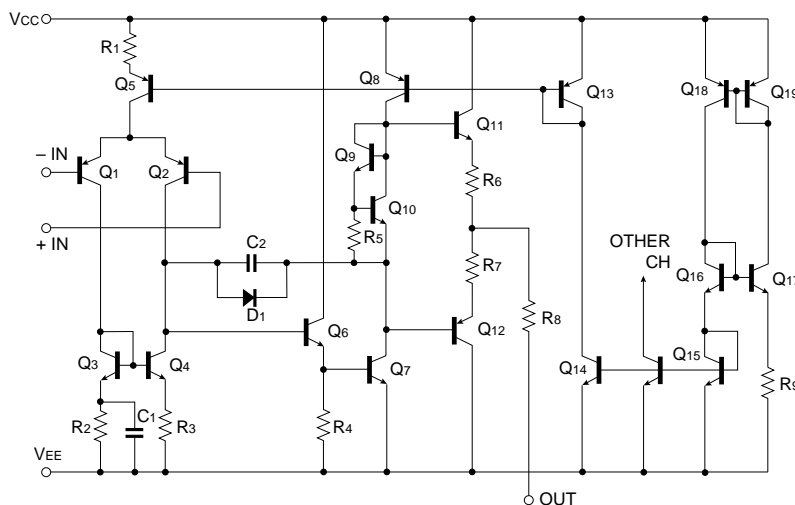

● Absolute maximum ratings (Ta = 25°C)

Parameter	Symbol	Limits			Unit
		BA15218	BA15218F	BA15218N	
Power supply voltage	V _{CC}	± 18	± 18	± 18	V
Power dissipation	P _d	800*	550*	900*	mW
Differential input voltage	V _{ID}	± V _{CC}	± V _{CC}	± V _{CC}	V
Common-mode input voltage	V _I	- V _{CC} ~ V _{CC}	- V _{CC} ~ V _{CC}	- V _{CC} ~ V _{CC}	V
Load current	I _{OMAX}	± 50	± 50	± 50	mA
Operating temperature	T _{opr}	- 40 ~ + 85	- 40 ~ + 85	- 40 ~ + 85	°C
Storage temperature	T _{stg}	- 55 ~ + 125	- 55 ~ + 125	- 55 ~ + 125	°C

* Refer to P_d characteristics diagram.

The values for the BA15218F are those when it is mounted on a glass epoxy board (50mm × 50mm × 1.6mm).

Standard ICs

BA15218 / BA15218F / BA15218N

●Electrical characteristics (unless otherwise noted, $T_a = 25^\circ\text{C}$, $V_{CC} = +15\text{V}$, $V_{EE} = -15\text{V}$)

Parameter	Symbol	Min.	Typ.	Max.	Unit	Conditions
Input offset voltage	V_{IO}	—	0.5	5	mV	$R_s \leq 10\text{k}\Omega$
Input offset current	I_{IO}	—	5	200	nA	—
Input bias current	I_B	—	50	500	nA	—
High-amplitude voltage gain	A_v	86	110	—	dB	$R_L \geq 2\text{k}\Omega$, $V_o = \pm 10\text{V}$
Common-mode input voltage	V_{ICM}	± 12	± 14	—	V	—
Maximum output voltage	V_{OH}	± 12	± 14	—	V	$R_L \geq 10\text{k}\Omega$
Maximum output voltage	V_{OL}	± 10	± 13	—	V	$R_L \geq 2\text{k}\Omega$
Common-mode rejection ratio	CMRR	70	90	—	dB	$R_s \leq 10\text{k}\Omega$
Power supply voltage rejection ratio	PSRR	76	90	—	dB	$R_s \leq 10\text{k}\Omega$
Quiescent current	I_Q	—	5	8	mA	$V_{IN} = 0\text{V}$, $R_L = \infty$
Slew rate	S.R.	—	3	—	V / μs	$A_v = 1$, $R_L = 2\text{k}\Omega$
Channel separation	CS	—	120	—	dB	$f = 1\text{kHz}$ input conversion
Voltage gain band width	GBW	—	10	—	MHz	$f = 10\text{kHz}$
Input conversion noise voltage	V_n	—	1.0	—	μV_{rms}	RIAA, $R_s = 1\text{k}\Omega$, 10Hz ~ 30kHz

●Electrical characteristic curves

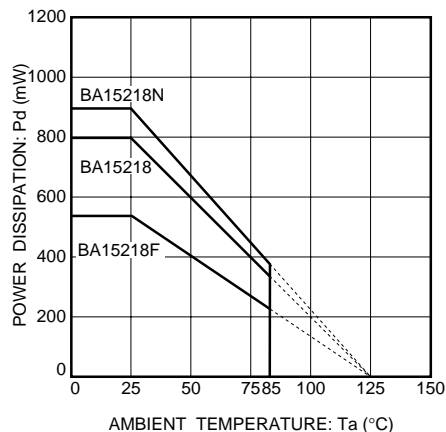

Fig.1 Power dissipation vs. ambient temperature

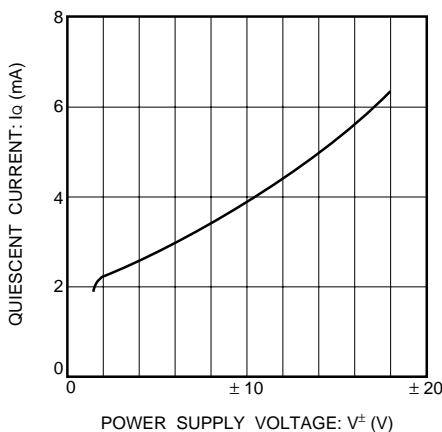

Fig.2 Quiescent current vs. power supply voltage

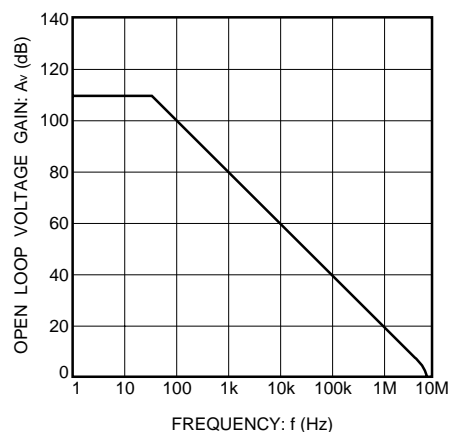

Fig.3 Open loop voltage gain vs. frequency

Standard ICs

BA15218 / BA15218F / BA15218N

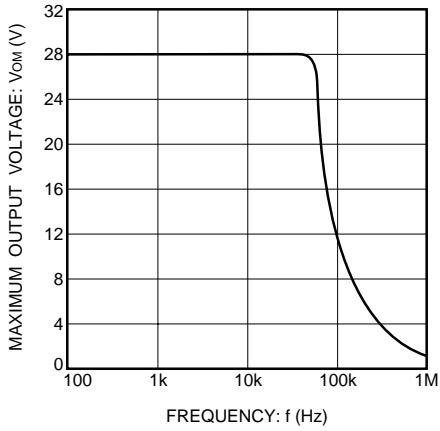

Fig.4 Maximum output voltage vs. frequency

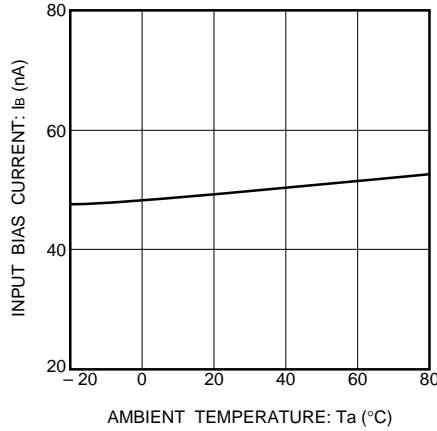

Fig.5 Input bias current vs. ambient temperature

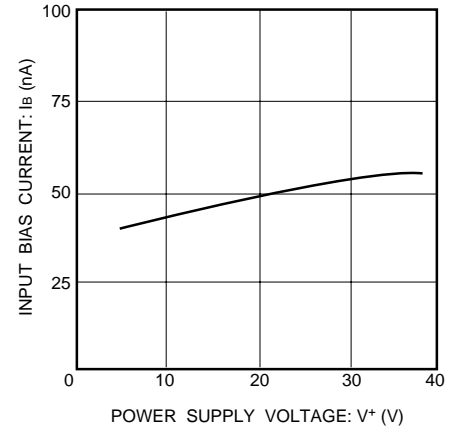

Fig.6 Input bias current vs. power supply voltage

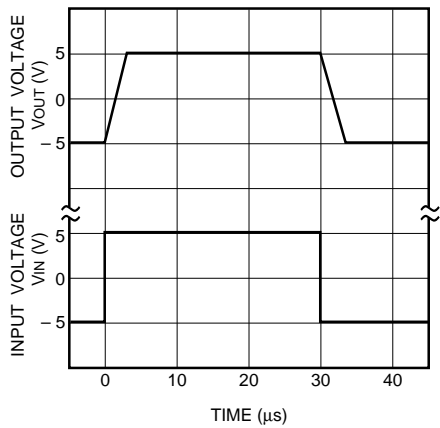

Fig.7 Output response characteristics

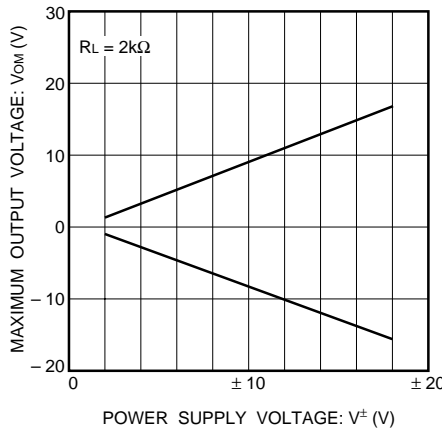

Fig.8 Maximum output voltage vs. power supply voltage

● Operation notes

(1) Unused circuit connections

If there are any circuits which are not being used, we recommend making connections as shown in Figure 9, with the non-inverted input pin connected to the potential within the in-phase input voltage range (V_{ICM}).

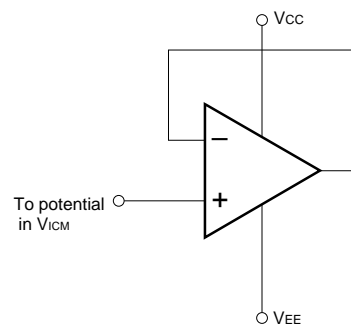
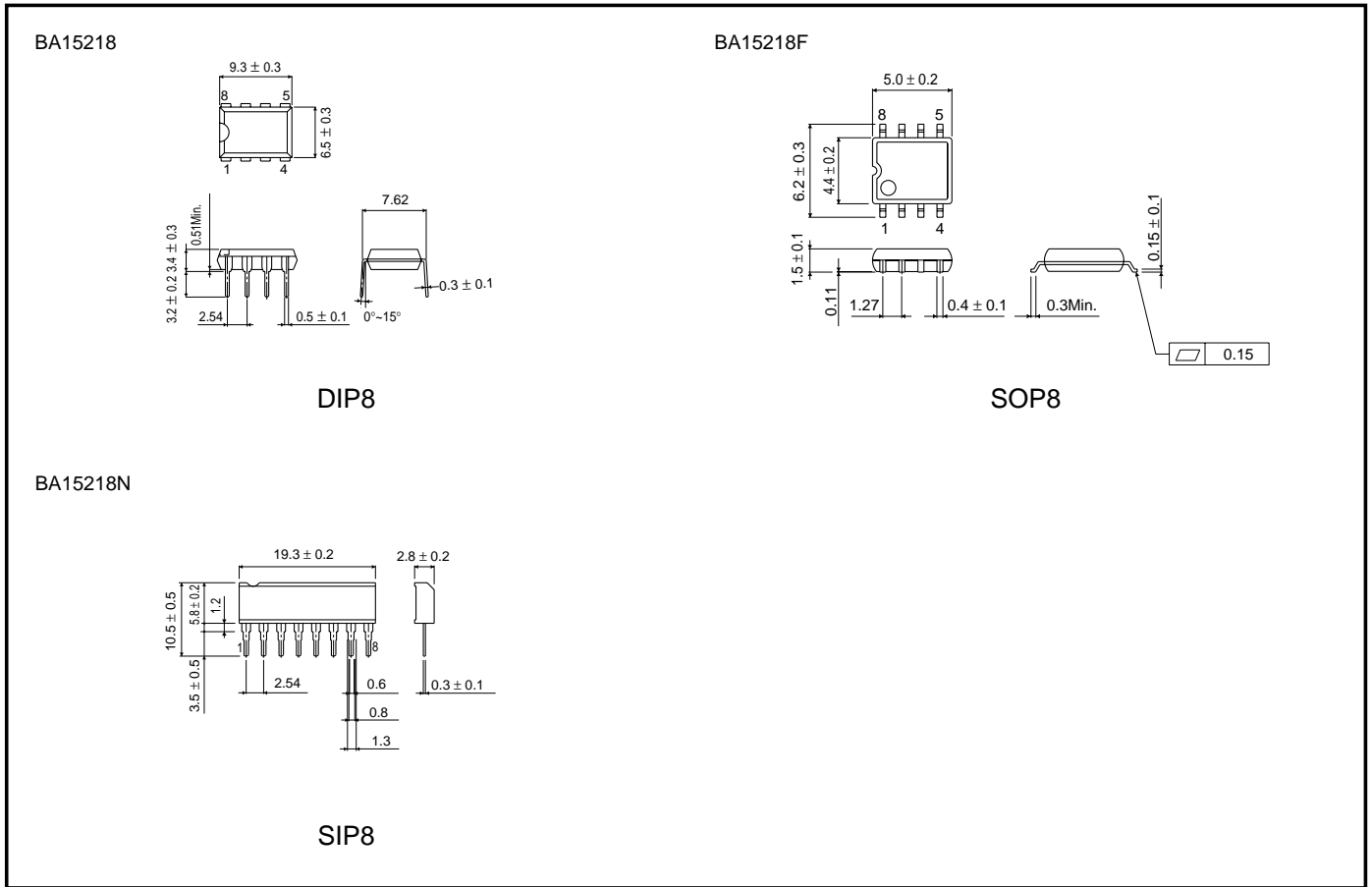

Fig.9 Unused circuit connections

Standard ICs

BA15218 / BA15218F / BA15218N

●External dimensions (Units: mm)



Appendix

Notes

- No technical content pages of this document may be reproduced in any form or transmitted by any means without prior permission of ROHM CO.,LTD.
- The contents described herein are subject to change without notice. The specifications for the product described in this document are for reference only. Upon actual use, therefore, please request that specifications to be separately delivered.
- Application circuit diagrams and circuit constants contained herein are shown as examples of standard use and operation. Please pay careful attention to the peripheral conditions when designing circuits and deciding upon circuit constants in the set.
- Any data, including, but not limited to application circuit diagrams information, described herein are intended only as illustrations of such devices and not as the specifications for such devices. ROHM CO.,LTD. disclaims any warranty that any use of such devices shall be free from infringement of any third party's intellectual property rights or other proprietary rights, and further, assumes no liability of whatsoever nature in the event of any such infringement, or arising from or connected with or related to the use of such devices.
- Upon the sale of any such devices, other than for buyer's right to use such devices itself, resell or otherwise dispose of the same, no express or implied right or license to practice or commercially exploit any intellectual property rights or other proprietary rights owned or controlled by
- ROHM CO., LTD. is granted to any such buyer.
- Products listed in this document use silicon as a basic material.
Products listed in this document are no antiradiation design.

The products listed in this document are designed to be used with ordinary electronic equipment or devices (such as audio visual equipment, office-automation equipment, communications devices, electrical appliances and electronic toys).

Should you intend to use these products with equipment or devices which require an extremely high level of reliability and the malfunction of which would directly endanger human life (such as medical instruments, transportation equipment, aerospace machinery, nuclear-reactor controllers, fuel controllers and other safety devices), please be sure to consult with our sales representative in advance.

About Export Control Order in Japan

Products described herein are the objects of controlled goods in Annex 1 (Item 16) of Export Trade Control Order in Japan.

In case of export from Japan, please confirm if it applies to "objective" criteria or an "informed" (by MITI clause) on the basis of "catch all controls for Non-Proliferation of Weapons of Mass Destruction.