

## **Excellent Integrated System Limited**

Stocking Distributor

Click to view price, real time Inventory, Delivery & Lifecycle Information:

[Rohm Semiconductor](#)  
[BA6418N](#)

For any questions, you can email us directly:

[sales@integrated-circuit.com](mailto:sales@integrated-circuit.com)

Motor driver ICs

# Reversible motor driver

## BA6418N

The BA6418N is a reversible-motor driver with a maximum output current of 0.7A. Two logic inputs allow four output modes: forward, reverse, stop (idling), and brake. Since logic and power sections have separate ground pins, the IC can drive speed-variable, reversible motors by connecting an electronic governor circuit.

●Features

- 1) Small standby circuit current.
- 2) Wide range of operating voltage. (4.5 ~ 15V)
- 3) Interfaces with TTL devices.
- 4) Built-in thermal shutdown circuit.

●Block diagram

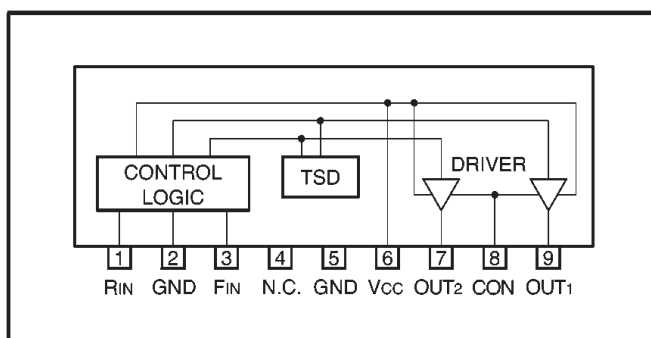

●Absolute maximum ratings (Ta = 25°C)

Parameter	Symbol	Limits	Unit
Power supply voltage	Vcc	18	V
Power dissipation	Pd	800*	mW
Operating temperature	Topr	-20~+60	°C
Storage temperature	Tstg	-55~+125	°C
Maximum output	Io	0.7	A

\* Reduced by 8 mW for each increase in Ta of 1°C over 25°C.

**Motor driver ICs**

**BA6418N**

●Input / output truth table

3pin (IN)	1pin (IN)	7pin (OUT)	9pin (OUT)
H	L	L	H
L	H	H	L
H	H	L	L
L	L	OPEN	OPEN

Note : HIGH level input is 2.0 V or more.

LOW level input is 0.8 V or less.

●Electrical characteristics (unless otherwise noted, Ta = 25°C, Vcc = 9V)

Parameter	Symbol	Min.	Typ.	Max.	Unit	Conditions
Operating voltage 1	V <sub>CC1</sub>	4.5	—	15	V	Pin 6-pin 2.5 voltage
Operating voltage 2	V <sub>CC2</sub>	4	—	15	V	Pin 6-pin 8 voltage
Supply current 1	I <sub>CC1</sub>	18	34	50	mA	1pin "H" , 3pin "L" or 1pin "L" 3pin "H" R <sub>L</sub> =∞
Supply current 2	I <sub>CC2</sub>	34	52	70	mA	1pin "H" , 3pin R <sub>L</sub> =∞
Standby supply current	I <sub>st</sub>	—	—	1.5	mA	1pin "L" , 3pin "L"
Input high level voltage	V <sub>IH</sub>	2.0	—	—	V	
Input low level voltage	V <sub>IL</sub>	—	—	0.8	V	
Input high level current	I <sub>IH</sub>	—	93	135	μA	V <sub>IN</sub> =2.0V
Output saturation voltage	V <sub>CE</sub>	—	1.2	1.6	V	I <sub>O</sub> =200mA Sum of output transistor high- and low-side voltages

●Input / output circuit (Equivalent circuit)

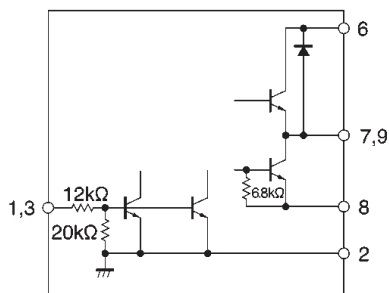

Fig.1

●Application example

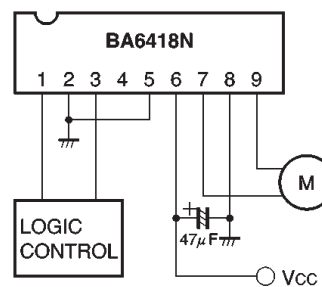

Fig.2

● Thermal derating curve

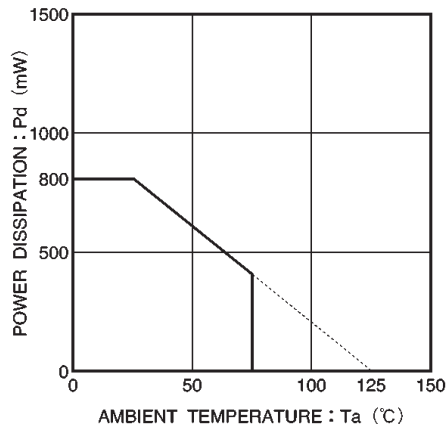

Fig.3 Temperature dependence of power dissipation curve

● Operation notes

(1) The quality of these products have been carefully checked; however, use of the products with applied voltages, operating temperatures, or other parameters that exceed the absolute maximum rating given may result in the damage of the IC and the product it is used in. If the IC is damaged, the short mode and open modes cannot be specified, so if the IC is to be used in applications where parameters may exceed the absolute maximum ratings, then be sure to incorporate fuses, or other physical safety measures.

(2) GND potential

The potential for pin 1 must be kept lower than the potentials of the other pins regardless of the circumstances.

(3) Input pins

Voltage should never be applied to the input pins when the  $V_{CC}$  voltage is not applied to the IC. Similarly, when  $V_{CC}$  is applied, the voltage on each input pin should be less than  $V_{CC}$  and within the guaranteed range for the electrical characteristics.

(4) Back-rush voltage

Depending on the ambient conditions, environment, or motor characteristics, the back-rush voltage may fluctuate. Be sure to confirm that the back-rush voltage will not adversely affect the operation of the IC.

(5) Large current line

Large currents are carried by the motor power supply and motor ground for these ICs.

Therefore, the layout of the pattern of the PC board and the constants of certain parameters for external components, such as the capacitor between the power supply and ground, may cause this large output current to flow back to the input pins, resulting in output oscillation or other malfunctions. To prevent this, make sure that the PC board layout and external circuit constants cause no problems with the characteristics of these ICs.

(6) Power dissipation

The power dissipation will fluctuate depending on the mounting conditions of the IC and the ambient environment. Make sure to carefully check the thermal design of the application where these ICs will be used.

(7) Power consumption

The power consumption by the IC varies widely with the power supply voltage and the output current. Give full consideration to the power dissipation rating and the thermal resistance data and transient thermal resistance data, to provide a thermal design so that none of the ratings for the IC are exceeded.

(8) Current consumption

The ratio of current consumption ( $I_{CC1}$  versus  $I_{CC2}$ ) is 1 : 2 for the logic section GND (pins 2 and 5) and the power section GND (pin 8).

(9) ASO

Make sure that the output current and supply voltage do not exceed the ASO values.

(10) Precautions for input mode switching

To ensure reliability, it is recommended that the mode switching for the motor pass once through the open mode.

(11) In-rush current

There are no circuits built into these ICs that prevent in-rush currents. Therefore, it is recommended to place a current limiting resistor or other physical countermeasure.

(12) Factors regarding the thermal, power supply, and motor conditions

If the potential of the output pin sways greatly and goes below the potential of ground, the operation of the IC may malfunction or be adversely affected. In such a case, place a diode between the output and ground, or other measure, to prevent this.

(13) Minimum operating voltage applied between power supply (pin 6) and COM (pin 8)

The minimum operating voltage applied between these pins is 4V at an ambient temperature of 25°C, but the voltage increases by 8mV (typical) for each degree below 25°C. Keep in mind this negative temperature dependence when setting the voltage at low ambient temperatures.

(14) Thermal shutdown circuit

When the thermal shutdown circuit is activated at the IC junction temperature of about 175°C (typical), all driver outputs are turned OFF. There is a temperature difference of about 15°C (typical) between the temperatures at which the circuit is activated and deactivated.

(15) To eliminate motor noise, connect a capacitor between OUT<sub>1</sub> (pin 9) and GND and between OUT<sub>2</sub> (pin 7) and GND. Alternatively, connect a capacitor between OUT<sub>1</sub> and OUT<sub>2</sub>, and also a diode between OUT<sub>1</sub> and GND and between OUT<sub>2</sub> and GND (see Fig. 4).

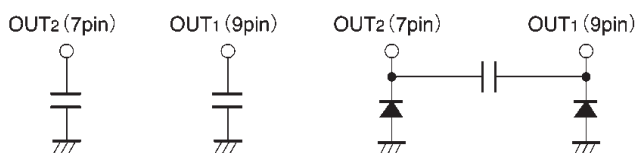

Fig.4

● Electrical characteristic curves

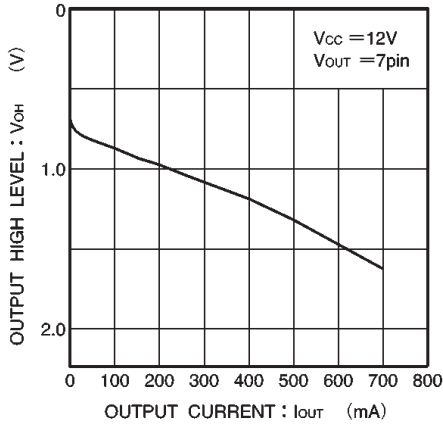

Fig.5 Output high level voltage vs. output current

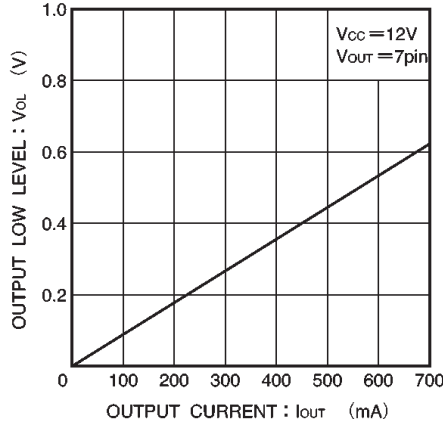

Fig.6 Output low level voltage vs. output current

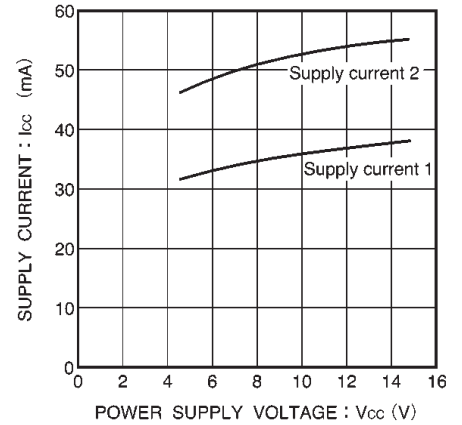

Fig.7 Supply current vs. power supply voltage

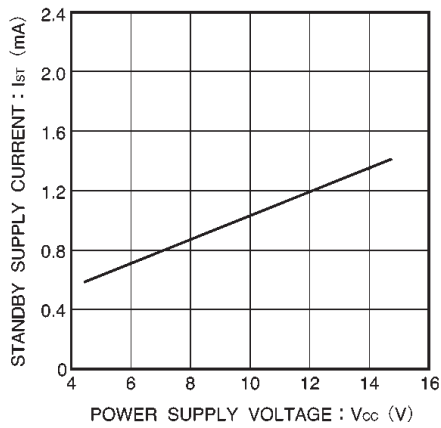

Fig.8 Standby supply current vs. power supply voltage

● External dimensions (Units: mm)

