

Excellent Integrated System Limited

Stocking Distributor

Click to view price, real time Inventory, Delivery & Lifecycle Information:

[Rohm Semiconductor](#)
[BH6150F-E2](#)

For any questions, you can email us directly:

sales@integrated-circuit.com

Memory ICs

System reset IC

BH6150F

The BH6150F has two reset circuits, one detects the power supply voltage, and the other detects the input voltage. With this one IC it is possible to apply a reset to the logic systems of CPUs, and mechanical systems.

●Applications

Personal computers, CPUs, MPUs, logic circuits, reset circuits for mechanical systems, level detector circuits, battery voltage detector circuits, and backup power supply switching circuits

●Features

Two types of reset circuit provided.

1) Reset circuit 1 (input voltage detector)

Detection voltage: 1.25V (Typ.)

Transmission delay time: 200 μ s (Typ.)

Open collector output, and 10k Ω pull-up resistor on chip.

2) Reset circuit 2 (supply voltage detector)

Detection voltage: 4.2V (Typ.)

Transmission delay time: 25, 50, 100 and 200 ms (select using the Ct0 and Ct1 pins)

Manual reset function provided

Open collector output, and 10k Ω pull-up resistor on chip.

●Absolute maximum ratings (Ta = 25°C)

Parameter	Symbol	Limits	Unit
Power supply voltage	V _{CC}	- 0.3 ~ + 7.0	V
Power dissipation	P _d	450*	mW
Operating temperature	T _{opr}	- 20 ~ + 75	°C
Storage temperature	T _{stg}	- 40 ~ + 125	°C

* Reduced by 4.5mW for each increase in Ta of 1°C over 25°C.

Memory ICs

BH6150F

●Block diagram

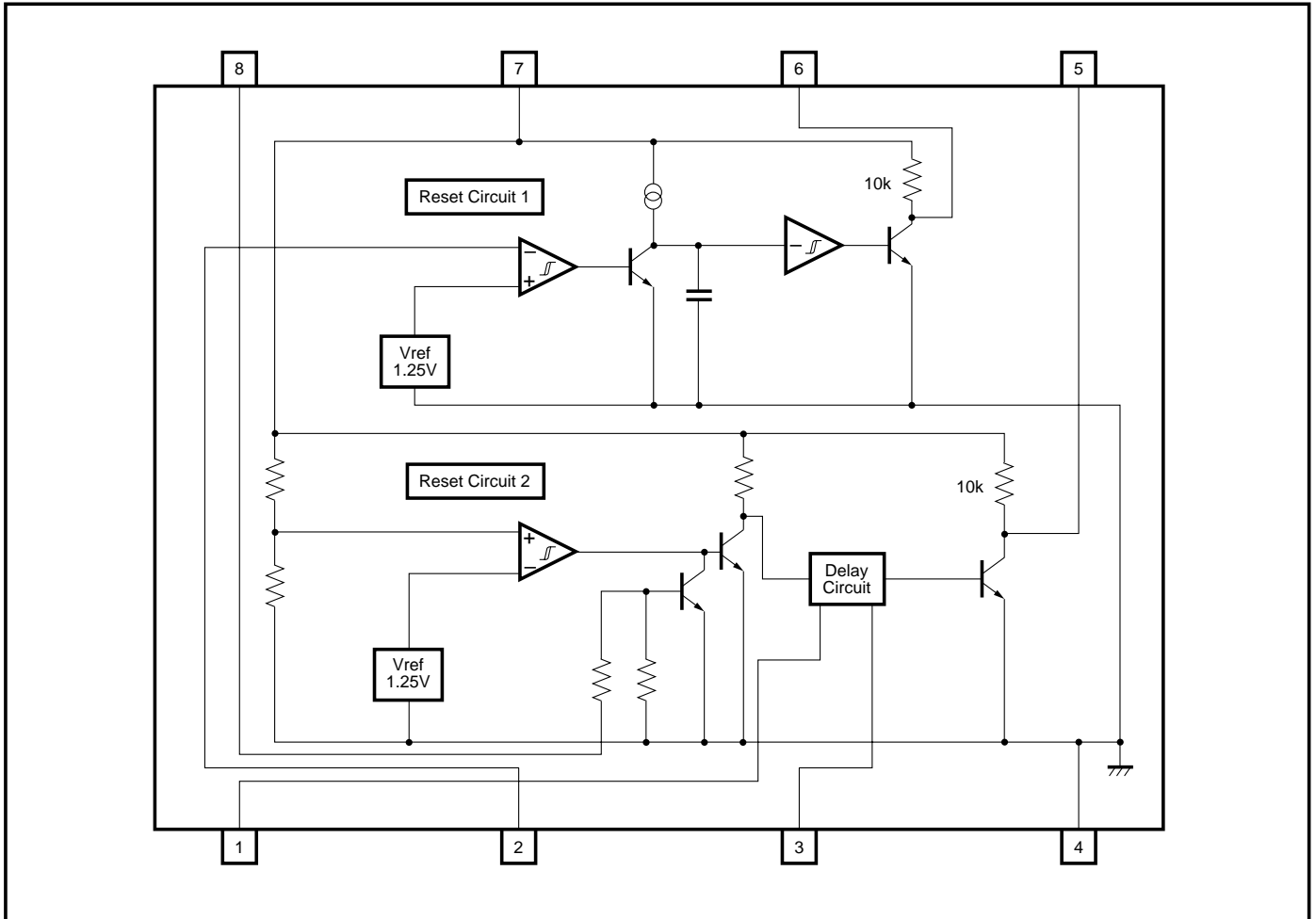

●Pin descriptions

Pin No.	Pin name	Function
1	Ct0	Delay time control*
2	Input	Reset circuit 1 input
3	Ct1	Delay time control*
4	GND	GND
5	Output 2	Reset circuit 2 output
6	Output 1	Reset circuit 1 output
7	Vcc	Power supply
8	Manual reset	Manual reset input

* When neither Ct0 or Ct1 are connected, the delay time is 100ms (Typ.).

Memory ICs

BH6150F

●Input / output circuits

Ct0, Ct1

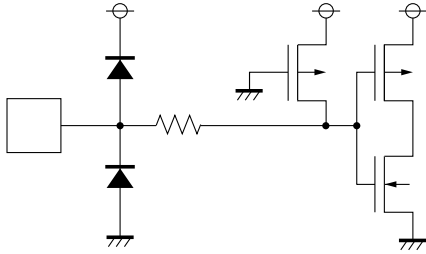

Input

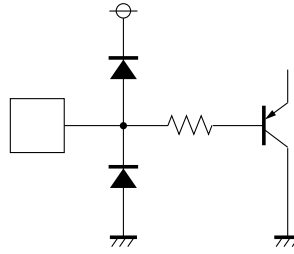

Manual reset

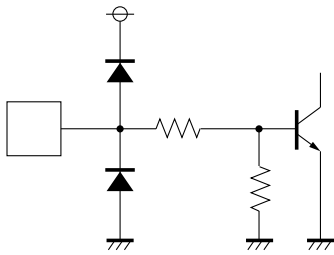

Output 1, Output 2

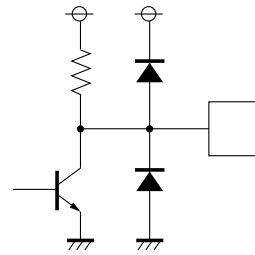

Memory ICs
BH6150F

 ●Electrical characteristics (unless otherwise specified $V_{CC} = 4.5V$ to $5.5V$ and $T_a = 25^{\circ}C$)

Reset circuit 1

Parameter	Symbol	Min.	Typ.	Max.	Unit	Conditions
Detection voltage	V_{S1}	1.20	1.25	1.30	V	—
Hysteresis voltage	ΔV_{S1}	9	15	23	mV	—
High level transmission delay time	T_{PLH1}	80	200	500	μs	$CL = 100pF$
Low level transmission delay time	T_{PHL1}	—	10	—	μs	$CL = 100pF$
Output low level voltage	V_{OL1}	—	0.1	0.4	V	$V_{IN} < 1.2V, I_{OL} = 5mA$
Input voltage range	V_{IN}	-0.3	—	V_{CC}	V	—
Input current	I_{IN}	—	200	500	nA	$V_{IN} = 1.25V$

Reset circuit 2

Parameter	Symbol	Min.	Typ.	Max.	Unit	Conditions	
Detection voltage	V_{S2}	4.0	4.2	4.4	V	—	
Hysteresis voltage	ΔV_{S2}	30	50	100	mV	—	
High level transmission delay time	T_{PLH2}	15	25	35	ms	$C_{t0} = L, C_{t1} = H$	
		30	50	70	ms	$C_{t0} = H, C_{t1} = L$	
		60	100	140	ms	$C_{t0} = H, C_{t1} = H$	
		120	200	280	ms	$C_{t0} = L, C_{t1} = L$	
Low level transmission delay time	T_{PHL2}	—	0.5	—	μs	$CL = 100pF$	
Output low level voltage	V_{OL2}	—	0.1	0.4	V	$V_{CC} < 4V, I_{OL} = 5mA$	
Manual reset	Input high level voltage	V_{RESH}	2	—	V_{CC}	V	—
	Input high level current	I_{RESH}	—	20	80	μA	$V_{RES} = 2V$
	Input low level voltage	V_{RESL}	-0.3	—	0.8	V	—

Common specifications

Parameter	Symbol	Min.	Typ.	Max.	Unit	Conditions
Circuit current when off	I_{CC1}	—	1000	1400	μA	$V_{CC} = 5V, V_{IN} > V_{S1}$
Circuit current when on	I_{CC2}	—	2	3	mA	$V_{CC} = 4V, V_{IN} < V_{S1}$
Detection voltage temperature coefficient	$V_S / \Delta T$	—	0.01	—	% / $^{\circ}C$	—
Output high level voltage	$V_{OH1,2}$	$V_{CC} - 0.7$	$V_{CC} - 0.4$	—	V	$I_{OH} = 40\mu A$
Operation limit voltage	$V_{OPL1,2}$	—	0.71	0.85	V	$V_{SAT} \leq 0.4V, R_L = 1K$

Memory ICs

BH6150F

● Measurement circuit

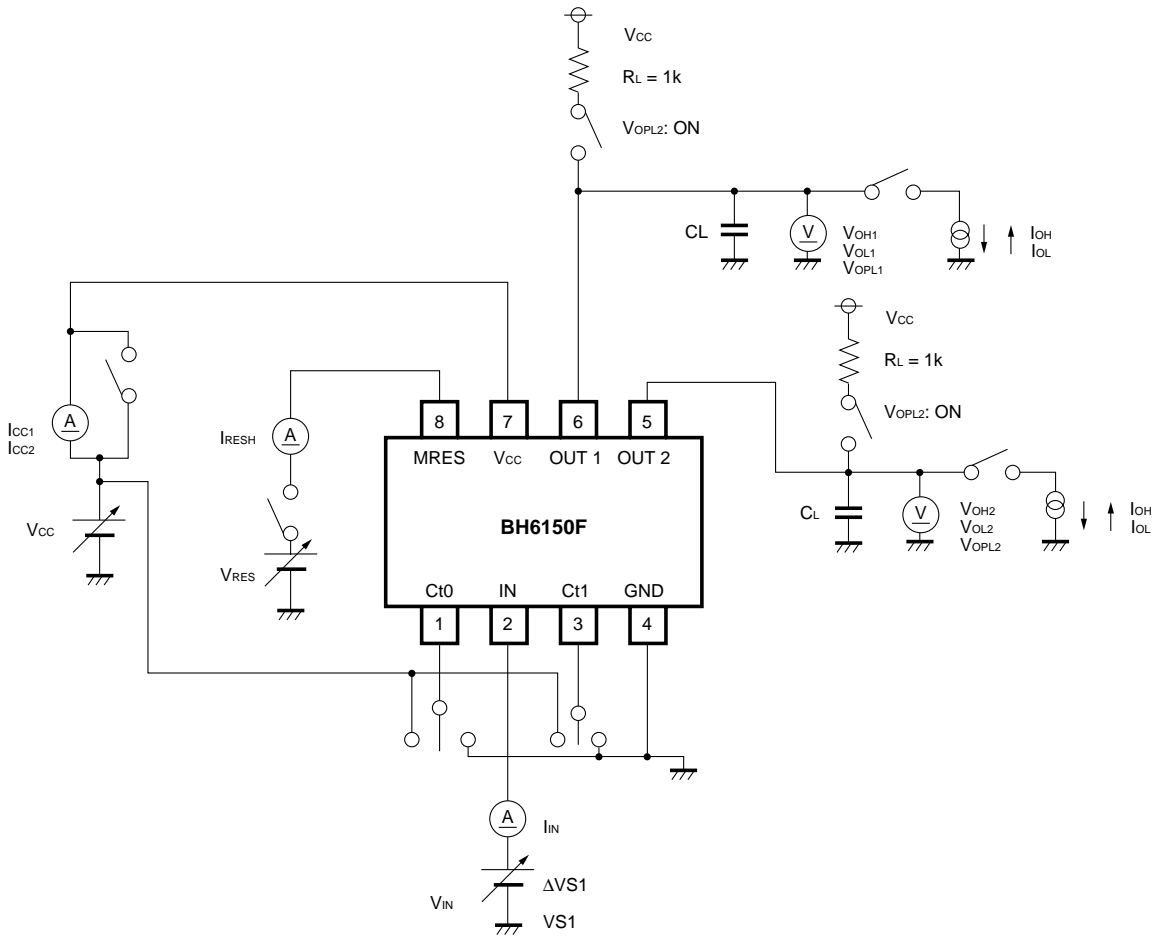

Memory ICs

BH6150F

●Circuit operation

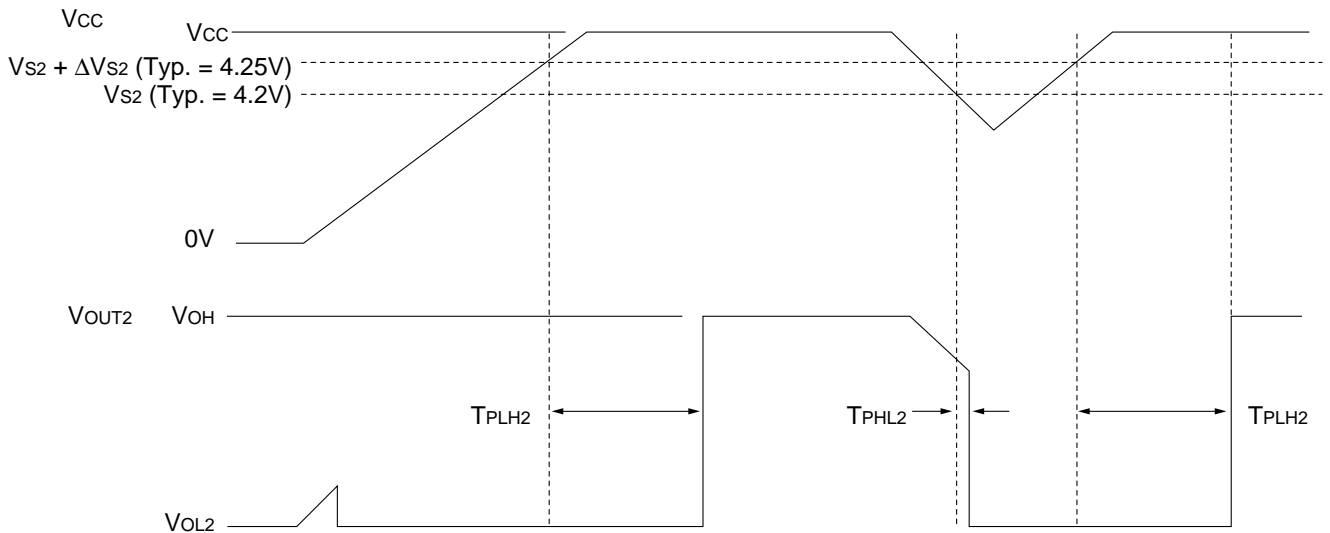
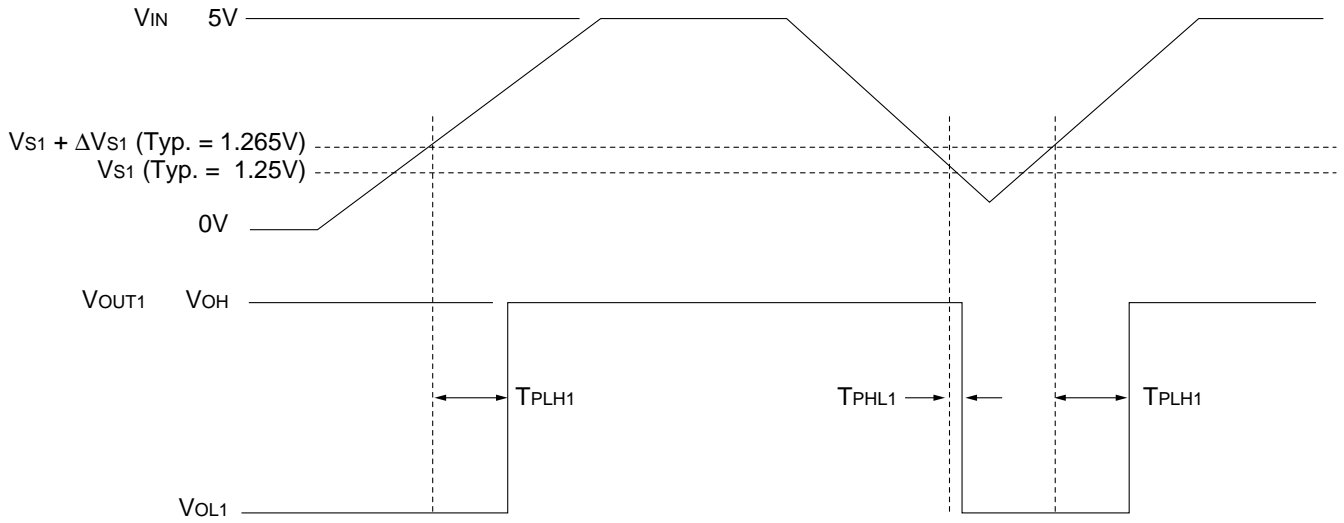

Memory ICs

BH6150F

●Electrical characteristic curves

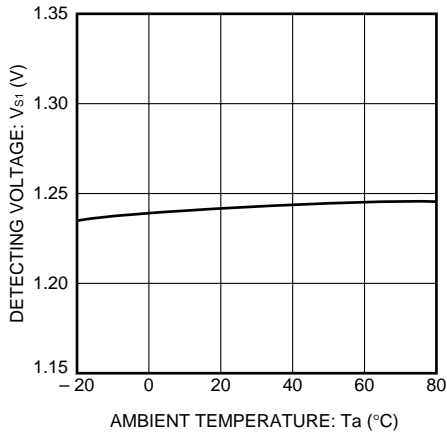

Fig. 1 Reset circuit 1 detector voltage vs. ambient temperature

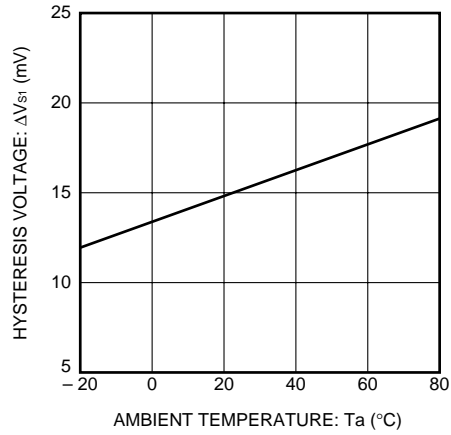

Fig. 2 Reset circuit 1 Hysteresis voltage vs. ambient temperature

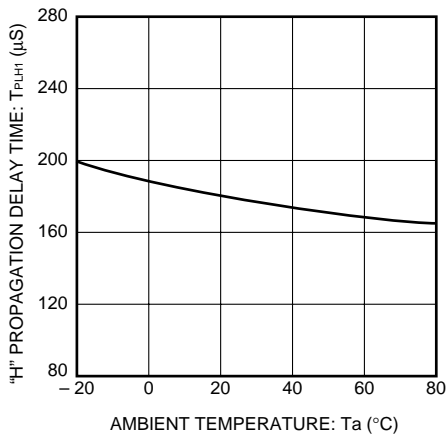

Fig. 3 Reset circuit 1 high level transmission delay time vs. ambient temperature

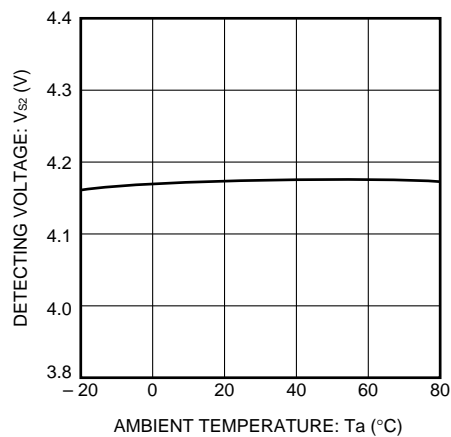

Fig. 4 Reset circuit 2 detector voltage vs. ambient temperature

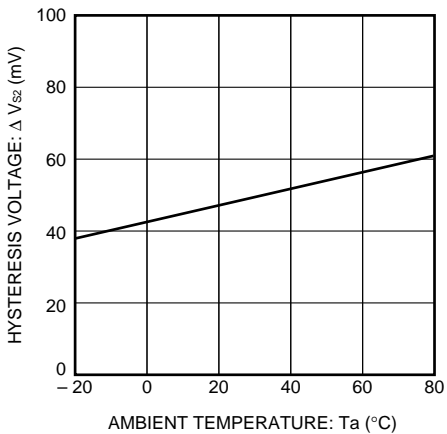

Fig. 5 Reset circuit 2 Hysteresis voltage vs. ambient temperature

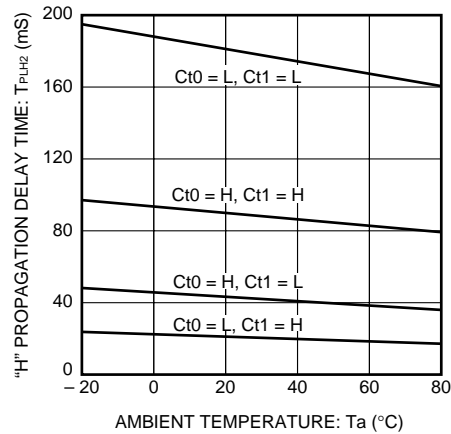

Fig. 6 Reset circuit 2 high level transmission delay time vs. ambient temperature

Memory ICs

BH6150F

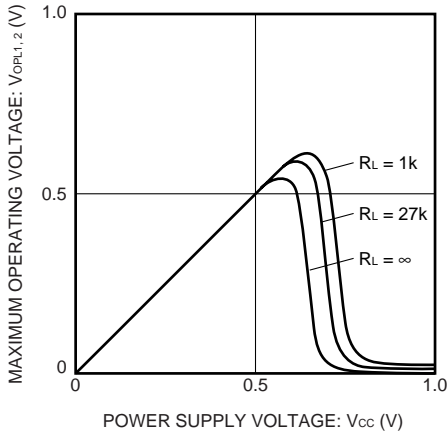

Fig. 7 Operation limit voltage vs. power supply voltage

●External dimensions (Units: mm)

