

## **Excellent Integrated System Limited**

Stocking Distributor

Click to view price, real time Inventory, Delivery & Lifecycle Information:

[Molex Connector Corporation](#)  
[0877581416](#)

For any questions, you can email us directly:  
[sales@integrated-circuit.com](mailto:sales@integrated-circuit.com)

10 9 8 7 6 5 4 3 2 1

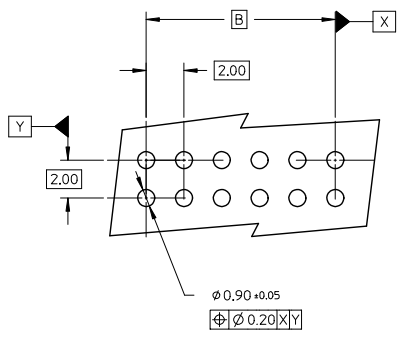
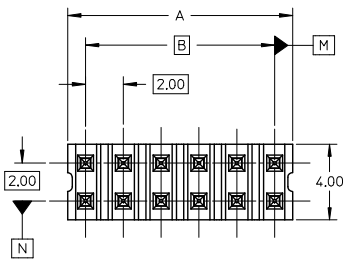

**LEGEND**  
87758-\*\*\*\*  
CKT SIZE (SEE SHT 2 TABLE) PLATING (SEE NOTE 2)

- NOTES:**
- MATERIAL:**  
HOUSING: 30% G.F. NYLON 46, 94V-0, COLOR: BLACK  
PIN: 0.50mm SQ. PHOSPHOR BRONZE 510
  - PLATING:**  
    - \*\*16 - 0.38um MIN GOLD IN CONTACT AREA, TIN IN SOLDER AREA, BOTH OVER NICKEL OVERALL.
    - \*\*17 - 0.76um MIN GOLD IN CONTACT AREA, TIN IN SOLDER AREA, BOTH OVER NICKEL OVERALL.
    - \*\*18 - 2.54um MIN TIN OVER NICKEL OVERALL.
    - \*\*19 - 0.05-0.25um GOLD IN CONTACT AREA, TIN IN SOLDER AREA, BOTH OVER NICKEL OVERALL.
  - 12 CKT USED FOR ILLUSTRATION ONLY
  - PACKED IN POCKET TRAY
  - PIN PUSHOUT FORCE: 1KG MIN IN EITHER DIRECTION
  - CKT 4 AND 6 IS CUT FROM CKT 8 AND 12 RESPECTIVELY. CKT 2 ARE CUT FROM ANY LARGER CKT SIZE. ROUGH EDGES ARE EXPECTED ALONG THE CUTTING EDGES.
  - PRODUCT SPEC PS-87761-100 APPLIES.
  - RECOMMENDED PCB THICKNESS IS 1.60±0.10

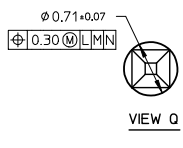
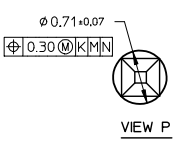
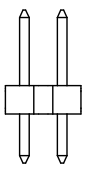
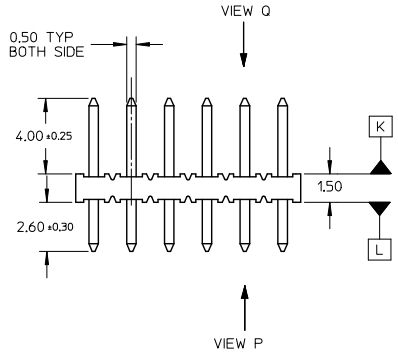

<b>ADD DATUMS</b> EC NO: S2014-0031 DRAWN BY: CHYK-SKANG CHECKED BY: CHYK-SKANG APPR: M LONG 2013/07/08 2013/07/08 2013/07/10	<b>QUALITY SYMBOLS</b> √=0 √=0 √=0	<b>GENERAL TOLERANCES (UNLESS SPECIFIED)</b>		<b>DIMENSION STYLE</b> MM ONLY		SCALE NTS	DESIGN UNITS METRIC	THIRD ANGLE PROJECTION	
		4 PLACES ± --- ± ---	mm INCH	DRAWN BY KSEE	DATE 2003/10/30	TITLE SALES DRAWING 2MM DUAL ROW SINGLE WAFER, VERTICAL T/H HDR			
		3 PLACES ± --- ± ---	± 0.20 ± ---	CHECKED BY KCLING	DATE 2004/01/05	MOLEX INCORPORATED			
		1 PLACE ± --- ± ---	ANGULAR ± 3 °	APPROVED BY SKTOH	DATE 2004/01/05	MATERIAL NO. SEE TABLE	DOCUMENT NO. SD-87758-107	SHEET NO. 1 OF 2	
DRAFT WHERE APPLICABLE MUST REMAIN WITHIN DIMENSIONS		SIZE A3		THIS DRAWING CONTAINS INFORMATION THAT IS PROPRIETARY TO MOLEX INCORPORATED AND SHOULD NOT BE USED WITHOUT WRITTEN PERMISSION					

9 8 7 6 5 4 3 2 1

PART NUMBER	CKT SIZE	A	B
87758-02**	2	NA	NA
87758-04**	4	NA	2.00
87758-06**	6	NA	4.00
87758-08**	8	7.90	6.00
87758-10**	10	9.90	8.00
87758-12**	12	11.90	10.00
87758-14**	14	13.90	12.00
87758-16**	16	15.90	14.00
87758-18**	18	17.90	16.00
87758-20**	20	19.90	18.00
87758-22**	22	21.90	20.00
87758-24**	24	23.90	22.00
87758-26**	26	25.90	24.00
87758-28**	28	27.90	26.00
87758-30**	30	29.90	28.00
87758-32**	32	31.90	30.00
87758-34**	34	33.90	32.00
87758-36**	36	35.90	34.00
87758-38**	38	37.90	36.00
87758-40**	40	39.90	38.00
87758-42**	42	41.90	40.00
87758-44**	44	43.90	42.00
87758-46**	46	45.90	44.00
87758-48**	48	47.90	46.00
87758-50**	50	49.90	48.00

CKT SIZE	PART NO. WITH CAP IN TUBE	PART NO. WITH CAP IN TAPE/REEL	PLATING TYPE
8	87758-0814	87758-0815	**16
22	87758-5126	87758-5111	MOLEX INC.

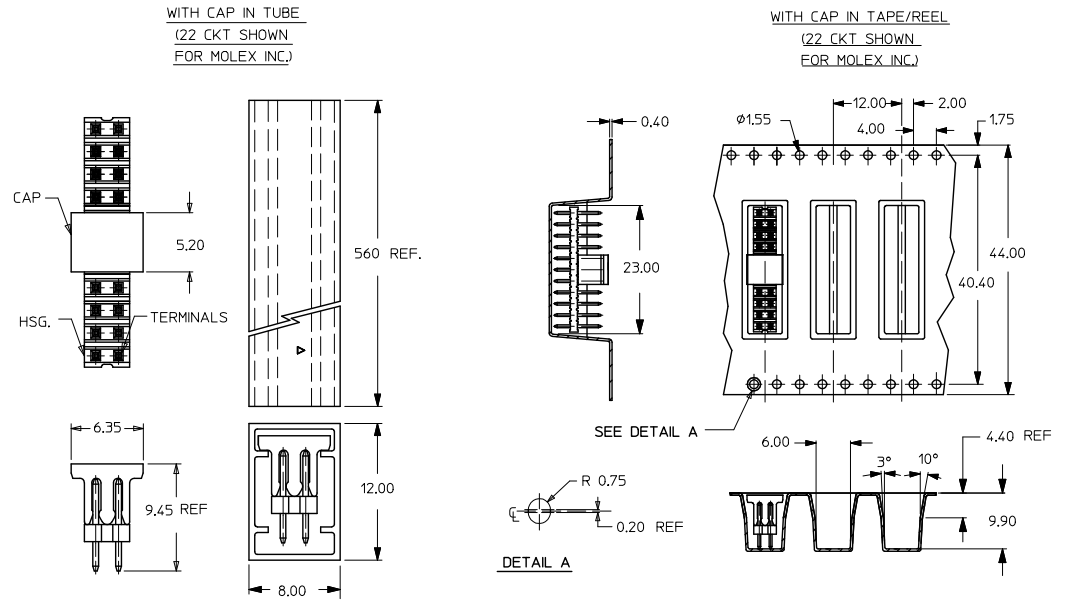

<b>ADD DATUMS</b> EC NO: S2014-0031 DRAWN/ISS: 2013/07/08 CHKD:SKANG APPR:HLONG 2013/07/10	<b>QUALITY SYMBOLS</b> √=0 √=0 √=0	<b>GENERAL TOLERANCES (UNLESS SPECIFIED)</b>		<b>DIMENSION STYLE</b> MM ONLY		SCALE NTS	DESIGN UNITS METRIC	THIRD ANGLE PROJECTION	
		4 PLACES ± --- ± ---	mm	INCH	DRAWN BY	DATE	TITLE SALES DRAWING 2MM DUAL ROW SINGLE WAFER, VERTICAL T/H HDR		
		3 PLACES ± --- ± ---	DRAFT WHERE APPLICABLE MUST REMAIN WITHIN DIMENSIONS		CHECKED BY	DATE	MOLEX INCORPORATED		
		2 PLACES ± 0.20 ± ---	MATERIAL NO. SEE TABLE		APPROVED BY	DATE	DOCUMENT NO. SD-87758-107	SHEET NO. 2 OF 2	