

Excellent Integrated System Limited

Stocking Distributor

Click to view price, real time Inventory, Delivery & Lifecycle Information:

[Panasonic Electronic Components](#)
[ELF-21C003A](#)

For any questions, you can email us directly:

sales@integrated-circuit.com

Panasonic

Line Filters

Combination Line Filters

Indonesia
Japan

Series: **C**
Type: **21C, 25C**



Type 21C

Combination Line Filters for attenuation of both common and normal mode noise.

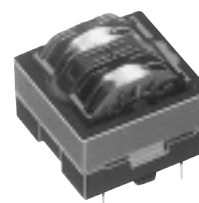

Type 25C□□□A

■ Features

- Excellent attenuation characteristics
- Compact size and high inductance
- Low profile, suitable for high density mounting

■ Recommended Applications

- Lighting, A/V, communications and power supply equipment



Type 25C□□□F

■ Explanation of Part Numbers

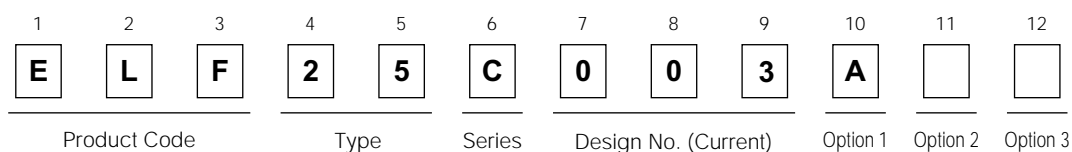

■ Performance Characteristics

Item	Series	Series C	Note
	Type	21C, 25C	
Operating Temperature		-20 °C to 115 °C *	
Voltage		AC 250 Vrms max.	
Current		Refer to examples	
Inductance		Refer to examples	
Dielectric Withstanding Voltage		AC 2 kV 1 min.	
Temperature Rise		45 K max.	Resistance method
Applicable Safety Standards **		Denki Yohin , UL, CSA, IEC	

* UL, CSA : -20 °C to 100 °C

** Only the combination line filter does not have safety standards recognition

Panasonic

Line Filters

■ Type 21C

● Dimensions in mm (not to scale)

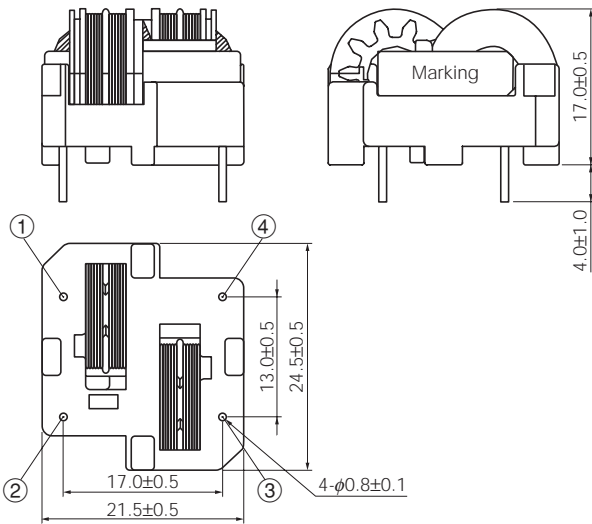

● Recommended PWB piercing plan (not to scale)

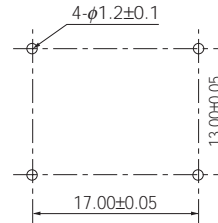

● Connection Schematics

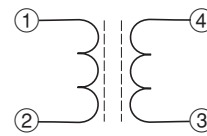

● Standard Parts

Part No.	Marking	Inductance (mH min.)			R _{DC} (at 20 °C)		Current (A rms) max.
		For Common Mode (mH) min.	For Normal Mode (mH)	Tol. (%)	(Ω)	Tol. (%)	
ELF21C003A	003A	43.0	1.700	±10	3.07	±20	0.3
ELF21C004A	004A	25.0	0.960		1.75		0.4
ELF21C006A	006A	11.0	0.440		0.79		0.6
ELF21C009A	009A	6.4	0.250		0.45		0.9
ELF21C011A	011A	3.9	0.150		0.30		1.1
ELF21C015A	015A	2.3	0.090		0.17		1.5
ELF21C018A	018A	1.7	0.065		0.12		1.8
ELF21C023A	023A	1.0	0.040		0.08		2.3

● Attenuation Characteristics

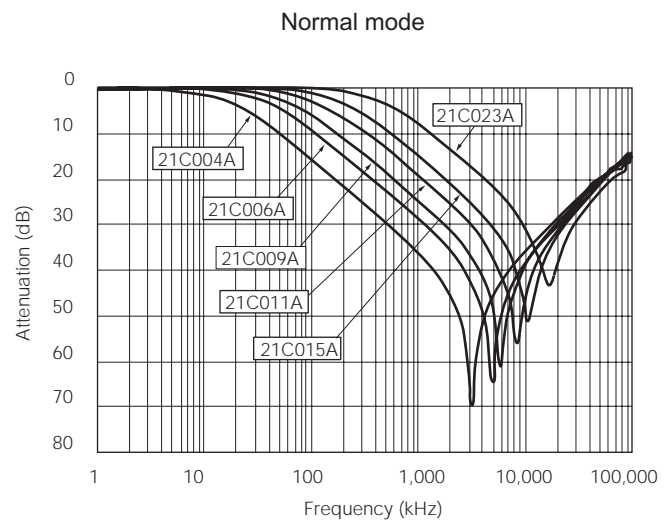
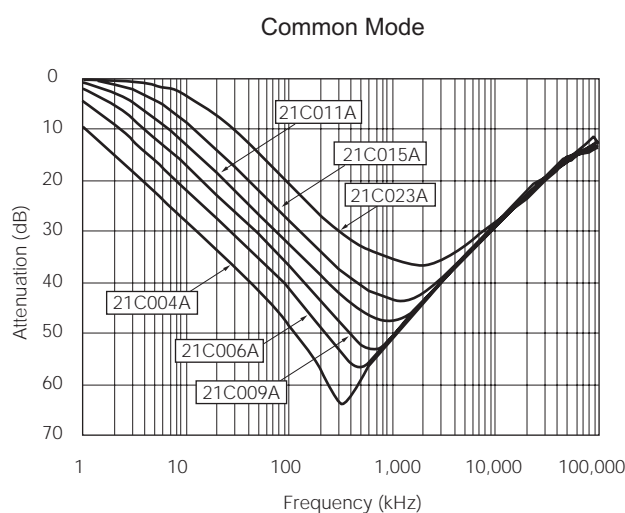

Panasonic

Line Filters

■ Type 25C

● Dimensions in mm (not to scale)

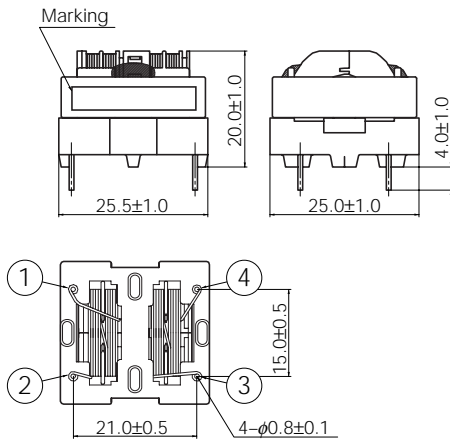

● Recommended PWB piercing plan (not to scale)

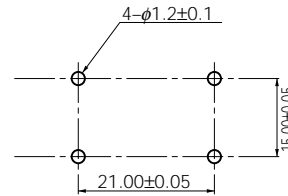

● Connection Schematics

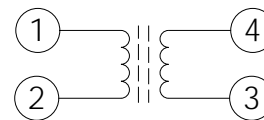

● Standard Parts

Part No.	Marking	Inductance		R _{DC} (at 20 °C)		Current (A rms) max.
		For Common Mode (mH) min.	For Normal Mode (mH) min.	(Ω)	Tol. (%)	
ELF25C003A	184 03	184.0	5.30	5.031	±20	0.3
ELF25C005A	723 05	72.0	2.10	1.891		0.5
ELF25C007A	343 07	34.0	0.90	0.916		0.7
ELF25C009A	203 09	20.0	0.52	0.510		0.9
ELF25C012A	113 12	11.0	0.31	0.310		1.2
ELF25C016A	672 16	6.7	0.18	0.180		1.6
ELF25C020A	442 20	4.4	0.11	0.113		2.0
ELF25C025A	302 25	3.0	0.08	0.080		2.5
ELF25C032A	182 32	1.8	0.05	0.053		3.2
ELF25C038A	122 38	1.2	0.03	0.037		3.8

● Attenuation Characteristics

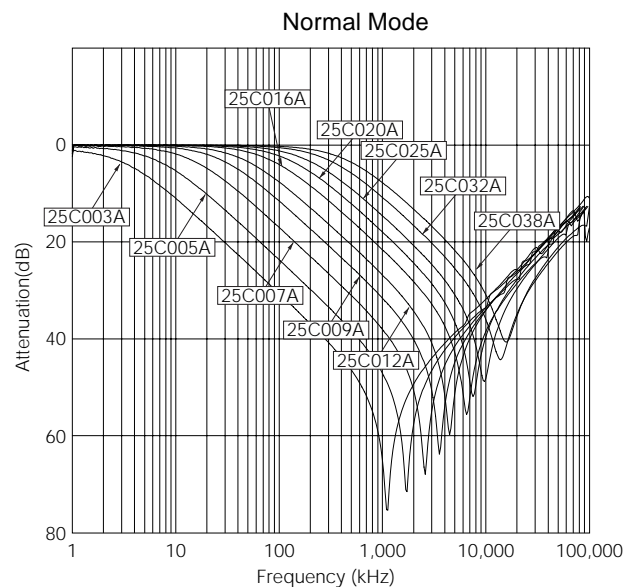
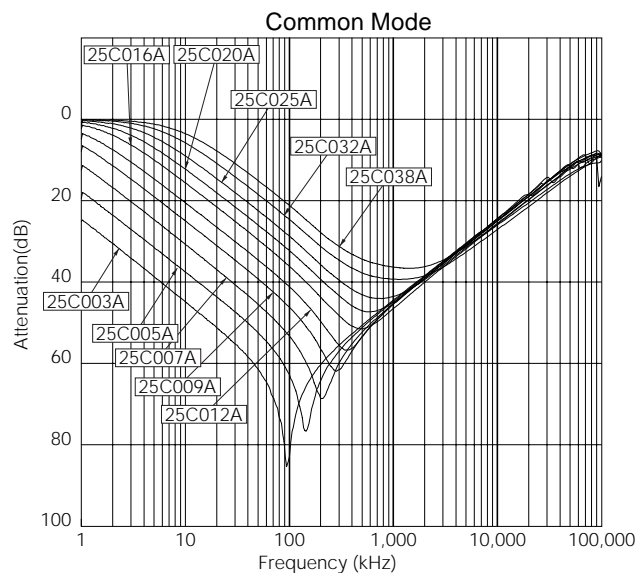

Panasonic

Line Filters

■ Type 25C□□□F

● Dimensions in mm (not to scale)

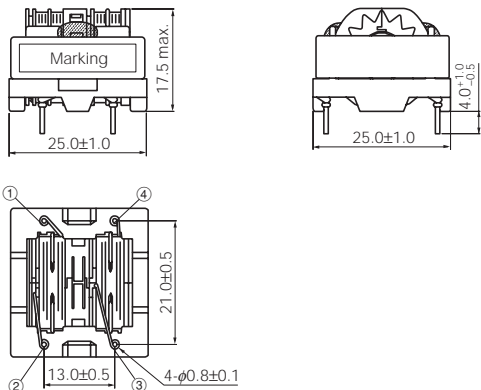

● Recommended PWB piercing plan (not to scale)

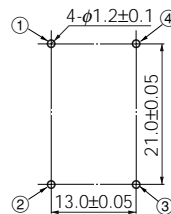

● Connection Schematics

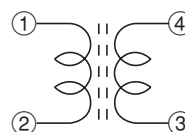

● Standard Parts

Part No.	Marking	Inductance		Rbc (at 20 °C)		Current (A rms) max.
		For Common Mode (mH) min.	For Normal Mode (mH) min.	(Ω)	Tol. (%)	
ELF25C005F	853 05F	85.0	2.10	1.891	±20	0.5
ELF25C006F	523 06F	52.0	1.28	1.270		0.6
ELF25C007F	343 07F	34.0	0.90	0.916		0.7
ELF25C008F	263 08F	26.0	0.68	0.673		0.8
ELF25C009F	203 09F	20.0	0.52	0.510		0.9
ELF25C012F	113 12F	11.0	0.31	0.310		1.2
ELF25C016F	672 16F	6.7	0.18	0.180		1.6
ELF25C020F	442 20F	4.4	0.11	0.113		2.0

● Attenuation Characteristics

Common Mode

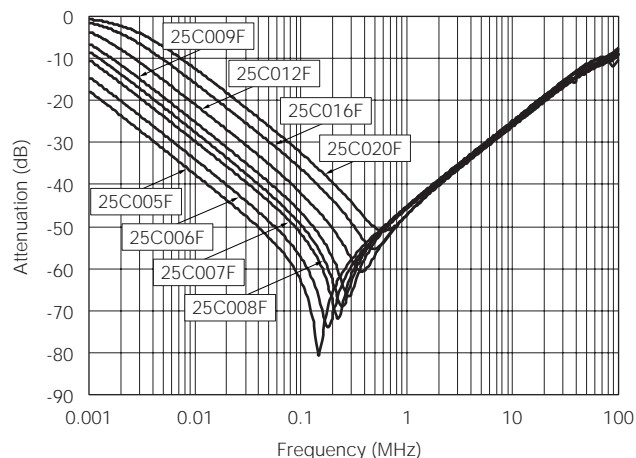

Normal Mode

