

Excellent Integrated System Limited

Stocking Distributor

Click to view price, real time Inventory, Delivery & Lifecycle Information:

[Pomona Electronics](#)
[4488](#)

For any questions, you can email us directly:

sales@integrated-circuit.com



**Model 4488, BNC (M)
 Compression Style Connector
 & Assembly Instructions** 

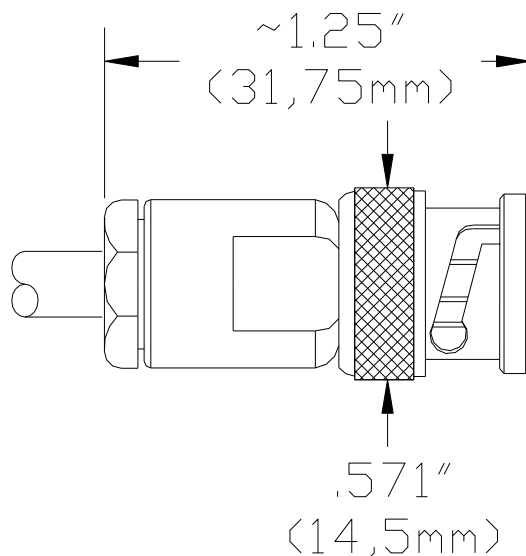

FEATURES:

- Do-it-yourself, field serviceable male BNC connector.
- Connector accepts cable types RG/U: 55, 55A, 55B, 58, 58C, 141, 141A, 142B, 223
- Meets interface requirements of MIL-STD-348

MATERIALS:

- Body and Fittings – Tarnish Resistant Nickel Plated Brass
- Outer Contact – Tarnish Resistant Nickel Plated Brass
- Center Contact – Gold Plated Brass
- Dielectric – PTFE
- Gasket – Silicone Rubber

RATINGS:

Voltage: Hands free usage in controlled voltage environments: 500 Vrms Max. *For CE compliance:* not intended for hand-held use at voltages above 33 Vrms/70Vdc.

Nominal Impedance: 50 Ohms

ORDERING INFORMATION: Model 4488

All dimensions are in inches. Tolerances (except noted): .xx = ±.02" (.51 mm), .xxx = ±.005" (.127 mm).
 All specifications are to the latest revisions. Specifications are subject to change without notice.
 Registered trademarks are the property of their respective companies.

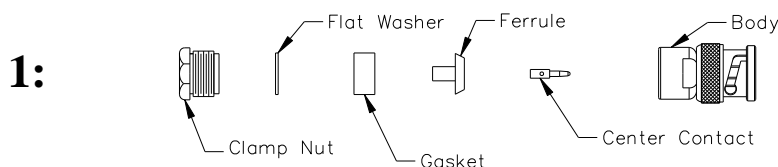

Style A

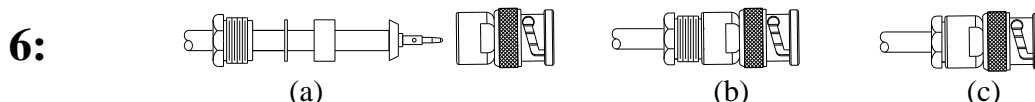
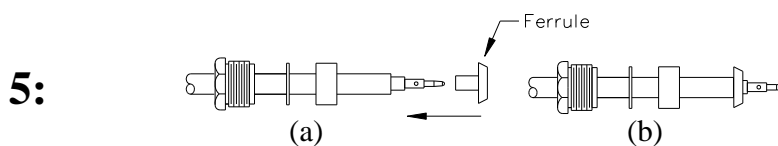
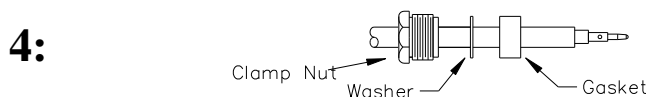
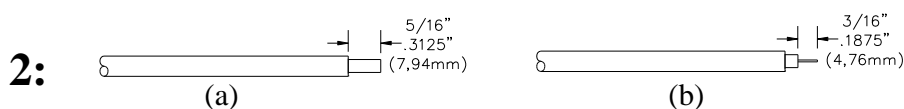

Assembly Instructions

1. Verify all parts are present.
2. (a) Cut outer jacket and shield 5/16" (7,94mm) from cable end to the depth of the dielectric. Remove outer insulation and coax shield. (b) Cut 3/16" (4,76mm) from the cable end to the depth of the center conductor and remove dielectric exposing center conductor.
3. Slide center pin contact onto center conductor, all the way against the dielectric. Solder or crimp to center contact.
4. Slide clamp nut, washer and gasket on to coax cable.
5. (a) Slide ferrule over dielectric and under the coax braided shield. (b) Verify that ferrule is pushed up against outer jacket .
6. (a) Push assembly into body until center contact "snaps" into body. (b) Slide clamp nut, washer, gasket forward. (c) Use 7/16" (11mm) wrench on the body and clamp nut, tighten to 18 – 22 in-lbs.

Registered trademarks are the property of their respective companies.

Sales: 800-490-2361 Fax: 888-403-3360 Technical Support: 800-241-2060 (technicalsupport@pomonatest.com)
 For "Where to Buy" information, visit the Pomona web site at www.pomonaelectronics.com

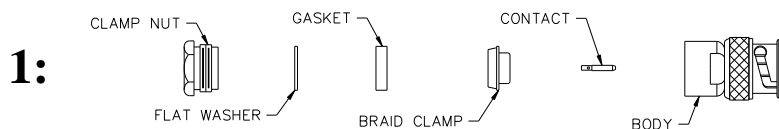

Style B

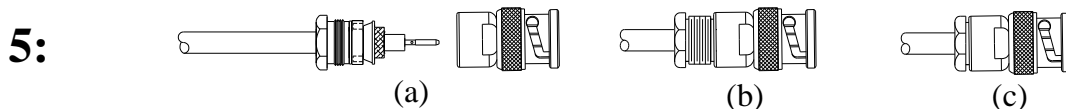
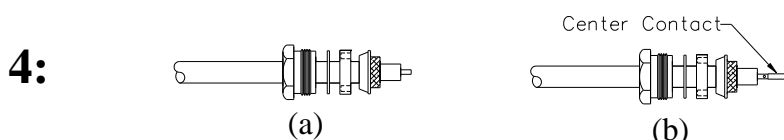
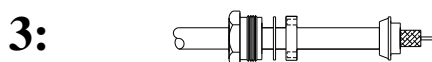
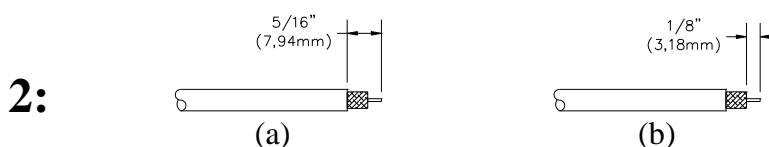

Assembly Instructions

1. Verify all parts are present.
2. (a) Cut outer jacket to the depth of the shield 5/16" (7,94mm) from cable end. Remove outer jacket.
 (b) Cut shield and dielectric to the depth of the center connector 1/8" (3,18 mm) from cable end. Remove shield and dielectric exposing center conductor.
3. Slide clamp nut, washer, gasket and braid clamp onto coax cable.
4. (a) Comb braid out and fold braid back over braid clamp. Trim braid even with braid clamp. (b) Slide center pin contact onto center conductor, all the way against the dielectric. Solder or crimp to center contact.
5. (a) Slide clamp nut, flat washer and gasket forward against braid clamp. (b) Push assembly into body. (c) Use 7/16" (11mm) wrench on the body and clamp nut, tighten to 35 – 40 in-lbs.

All dimensions are in inches. Tolerances (except noted): .xx = ±.02" (.51 mm), .xxx = ±.005" (.127 mm).
 All specifications are to the latest revisions. Specifications are subject to change without notice.
 Registered trademarks are the property of their respective companies.

Sales: 800-490-2361 Fax: 888-403-3360 Technical Support: 800-241-2060 (technicalsupport@pomonatest.com)
 For "Where to Buy" information, visit the Pomona web site at www.pomonaelectronics.com