

Excellent Integrated System Limited

Stocking Distributor

Click to view price, real time Inventory, Delivery & Lifecycle Information:

[GE Critical Power](#)
[QW020A0G71-H](#)

For any questions, you can email us directly:

sales@integrated-circuit.com

Data Sheet

March 27, 2008



**QW010/015/020-H Series Power Modules with Baseplate;
36 – 75Vdc Input, 1.0 - 5.0Vdc Output; 10A to 20A Output Current**

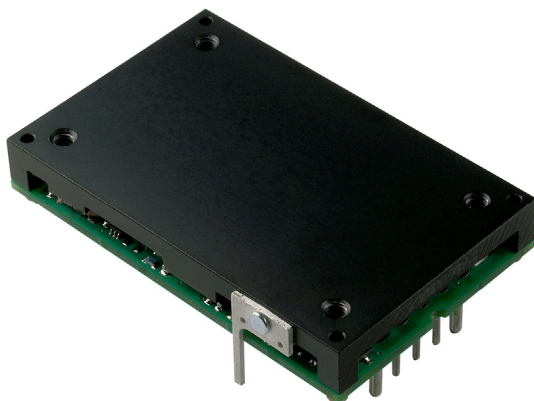

Description

The QW-H series dc-dc converters are same as QW series with baseplate mounted on topside, which accommodate for standard quarter brick heatsink attachment. The QW-H series allow customer to operate the module in an extreme thermal environment with attachment of heatsink/cold-plate for proper cooling of internal component to heighten reliable and consistent operation. For additional technical data, consult QW010/0150/020 series data sheet.

**QW010/015/020 Series Brick Power Modules:
36 - 75Vdc Input; 1.0Vdc to 5Vdc Output; 10A to 20A Output current**

**Data Sheet
March 27, 2008**

Mechanical Outline Diagram

Dimensions are in inches.

Tolerances: x.xx in. ± 0.02 in. [unless otherwise indicated]
 x.xxx in ± 0.010 in.

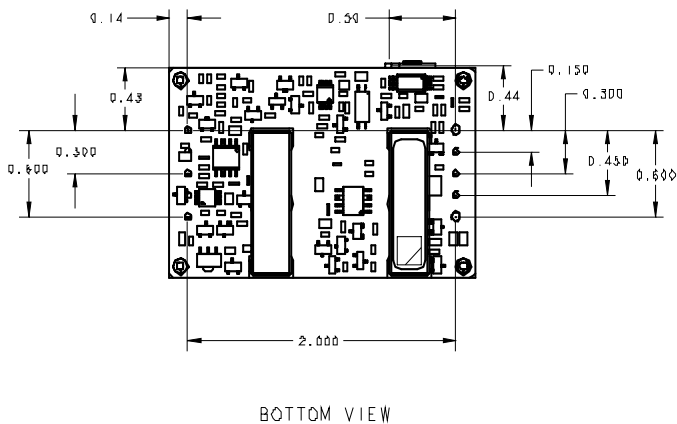
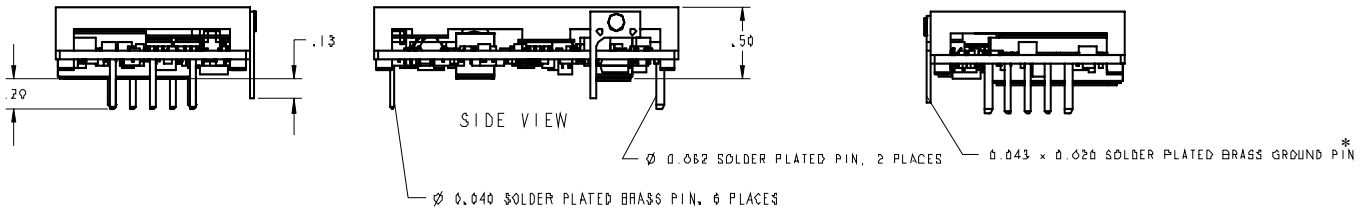
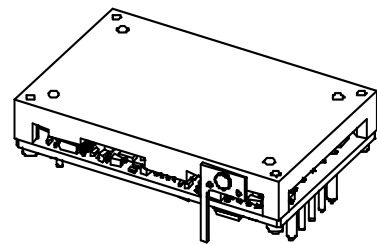
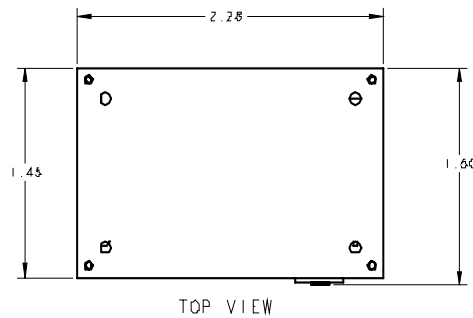

* Ground pin is optional

**QW010/015/020 Series Brick Power Modules:
 36 - 75Vdc Input; 1.0Vdc to 5Vdc Output; 10A to 20A Output current**

**Data Sheet
 March 27, 2008**

Thermal considerations

The baseplate option (-H) power modules are constructed with baseplate on topside of the open frame power module. The baseplate includes quarter brick through-threaded, M3 x 0.5 mounting hole pattern, which enable heat sinks or cold plates to attach to the module. The mounting torque must not exceed 0.56 N-m (5 in.-lb.) during heat sink assembly. This module operates in a variety of thermal environments; however, sufficient cooling should be provided to help ensure reliable operation.

Considerations include ambient temperature, airflow, module power dissipation, and the need for increased reliability. A reduction in the operating temperature of the module will result in an increase in reliability. The thermal data presented here is based on physical measurements taken in a wind tunnel.

Heat-dissipating components are mounted on the top-side of the module and coupled to the baseplate with thermal gap material. Heat is removed by conduction, convection and radiation to the surrounding environment. The thermal reference point, T_{ref} , used for the derating curves is shown in Figure 1. For reliable operation T_{ref} temperature should not exceed 118°C.

The output power of the module should not exceed the rated power for the module as listed in the Ordering Information table. Although the maximum T_{ref} temperature of the power modules is 118°C, users can limit this temperature to a lower value for extremely high reliability.

Please refer to the Application Note “Thermal Characterization Process For Open-Frame Board-Mounted Power Modules” for a detailed discussion of thermal aspects including maximum device temperatures.

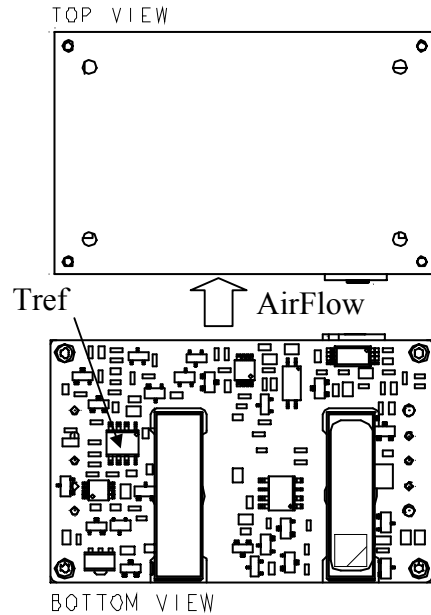

Figure 1. T_{ref} Temperature Measurement Location

Heat Transfer via Convection

Increased airflow over the module enhances the heat transfer via convection. Following derating figures shows the maximum output current that can be delivered by each module in the respective orientation without exceeding the maximum T_{ref} temperature versus local ambient temperature (T_A) for natural convection through 1m/s (200 ft./min).

Note that the natural convection condition was measured at 0.05 m/s to 0.1 m/s (10ft./min. to 20 ft./min.); however, systems in which these power modules may be used typically generate natural convection airflow rates of 0.3 m/s (60 ft./min.) due to other heat dissipating components in the system.

**QW010/015/020 Series Brick Power Modules:
 36 - 75Vdc Input; 1.0Vdc to 5Vdc Output; 10A to 20A Output current**

**Data Sheet
 March 27, 2008**

Thermal considerations (continued)

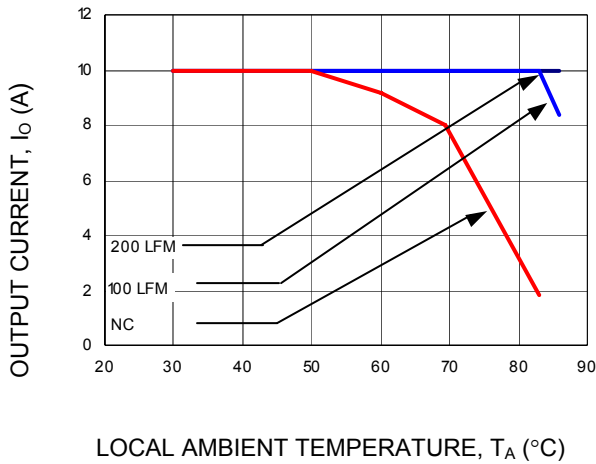

Figure 2. Derating curves for QW010A0A1-H (Vo = 5.0) in transverse orientation (Vin = 48Vdc)

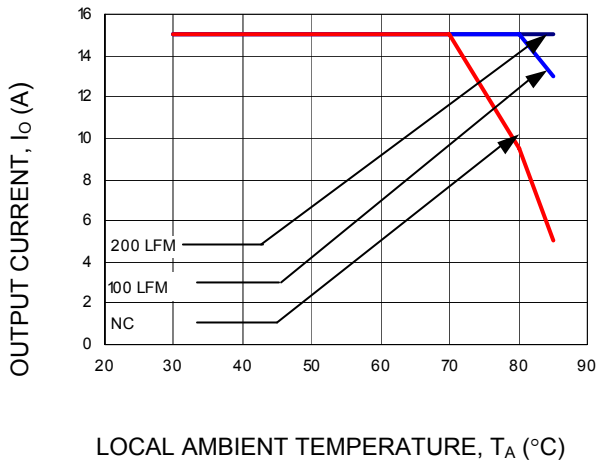

Figure 3. Derating curves for QW015A0F1-H (Vo = 3.3V) in transverse orientation (Vin = 48Vdc)

**QW010/015/020 Series Brick Power Modules:
36 - 75Vdc Input; 1.0Vdc to 5Vdc Output; 10A to 20A Output current**

**Data Sheet
March 27, 2008**

Ordering Information

Please contact your Lineage Power Sales Representative for pricing, availability and optional features.

Table 1. Device Codes

Input Voltage	Output Voltage	Output Current	Efficiency	Connector Type	Product codes	Comcodes
48V (36-75Vdc)	5.0	10A	92 %	Through hole	QW010A0A1-H	108979477
48V (36-75Vdc)	3.3V	15A	91 %	Through hole	QW015A0F-H	108985177
48V (36-75Vdc)	2.5V	20A	89 %	Through hole	QW020A0G71-H	108987082

Table 2. Device Options

Option	Suffix
Negative remote on/off logic	1
Case ground pin	7
Basic Insulation	-B



World Wide Headquarters
Lineage Power Corporation
 3000 Skyline Drive, Mesquite, TX 75149, USA
+1-800-526-7819
 (Outside U.S.A.: **+1-972-284-2626**)
www.lineagepower.com
e-mail: techsupport1@lineagepower.com

Asia-Pacific Headquarters
 Tel: +65 6416 4283

Europe, Middle-East and Africa Headquarters
 Tel: +49 89 6089 286

India Headquarters
 Tel: +91 80 28411633

Lineage Power reserves the right to make changes to the product(s) or information contained herein without notice. No liability is assumed as a result of their use or application. No rights under any patent accompany the sale of any such product(s) or information.

© 2008 Lineage Power Corporation, (Mesquite, Texas) All International Rights Reserved.