

Excellent Integrated System Limited

Stocking Distributor

Click to view price, real time Inventory, Delivery & Lifecycle Information:

[Panasonic Electronic Components](#)
[EVQ-QFV02K](#)

For any questions, you can email us directly:

sales@integrated-circuit.com

Panasonic

Light Touch Switches/EVQQF

2 mm Thick SMD Light Touch Switches
for Reflow Soldering (Without Push Plate)

Japan

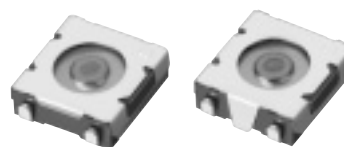

Type: **EVQQF**

■ Features

- 2.0 mm-high chip Light Touch Switches
- Reflow soldering available
- High reliability due to sealed structure
- Ground terminal option

■ Recommended Applications

- Operating switches for camcorders, headphone stereos
- Operating signal input switches for communication equipments

■ Explanation of Part Numbers

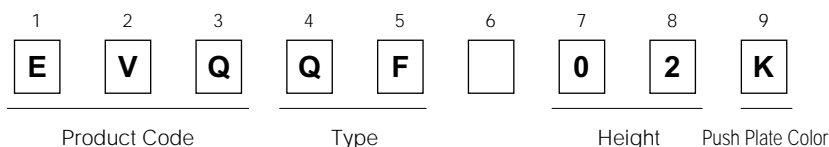

■ Product Chart

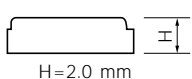
Type without Push Plate	Soldering		Reflow soldering	
	Packaging		Taping	
	Ground terminal		Without	With
Profile  H=2.0 mm	Operating Force	1.3 N	EVQQFV	EVQQFY

■ Specifications

Type		Snap action/Push-on type SPST
Electrical	Rating	20 mA 15 Vdc max. (Resistive load)
	Contact Resistance	50 mΩ max.
	Insulation Resistance	50 MΩ min. (at 100 Vdc)
	Dielectric Withstanding Voltage	250 Vac for 1 minute
	Bouncing	3 ms max. (ON) 8 ms max. (OFF)
Mechanical	Operating Force	1.3 N±0.4 N
	Travel	0.25 mm±0.10 mm
Endurance	Operating Life	100000 cycles min.*
	Operating Temperature	-20 °C to +70 °C (45 % to 85 % RH)
	Storage Temperature	-40 °C to +85 °C (Bulk) -20 °C to +60 °C (Taping)
Minimum Quantity/Packing Unit		4000 pcs. Embossed Taping (Reel Pack)
Quantity/Carton		20000 pcs.

Note: Non washable

* 1 million cycles also available, consult our salesmen.

Panasonic

Light Touch Switches/EVQQF

■ Dimensions in mm (not to scale)

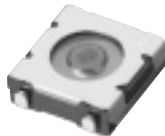
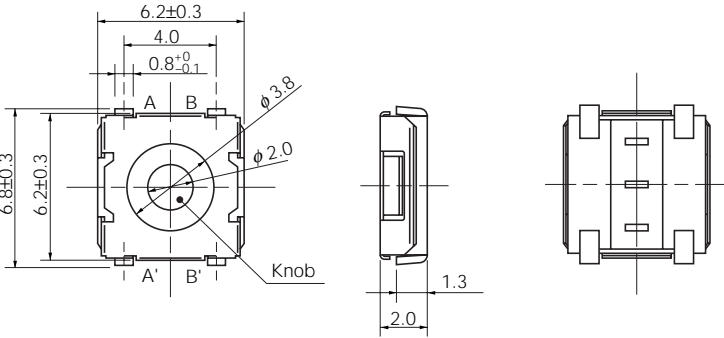
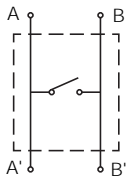
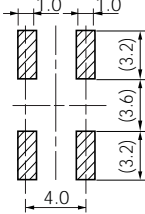
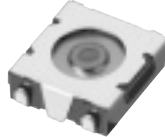
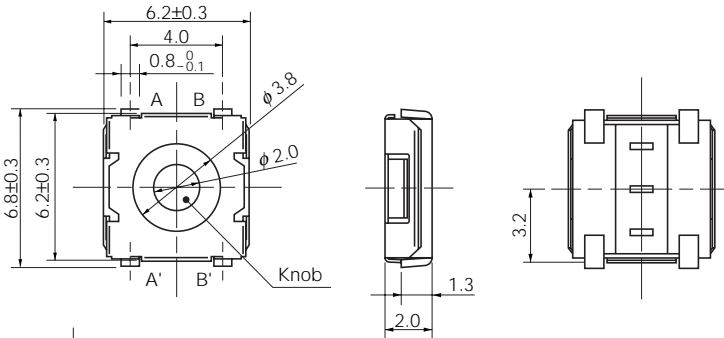
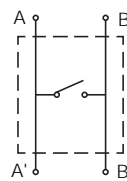
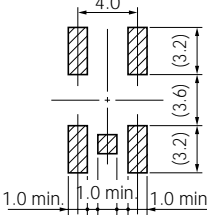
<p>No. 1</p> <p>EVQQFV</p> <p>(Embossed Taping)</p> <p>Surface mount For reflow soldering Without ground terminal</p> 	  <p>Circuit diagram</p>  <p>Recommended land pattern</p>		
<p>Part Numbers</p>	<p>Operating Force</p>	<p>Height</p>	<p>Operating Life</p>
<p>EVQQFV02K</p>	<p>1.3 N</p>	<p>2.0 mm</p>	<p>100000 cycles</p>
<p>No. 2</p> <p>EVQQFY</p> <p>(Embossed Taping)</p> <p>Surface mount For reflow soldering With ground terminal</p> 	  <p>Circuit diagram</p>  <p>Recommended land pattern</p>		
<p>Part Numbers</p>	<p>Operating Force</p>	<p>Height</p>	<p>Operating Life</p>
<p>EVQQFY02K</p>	<p>1.3 N</p>	<p>2.0 mm</p>	<p>100000 cycles</p>

Panasonic

Light Touch Switches/EVQQF

Recommended Reflow Soldering Conditions

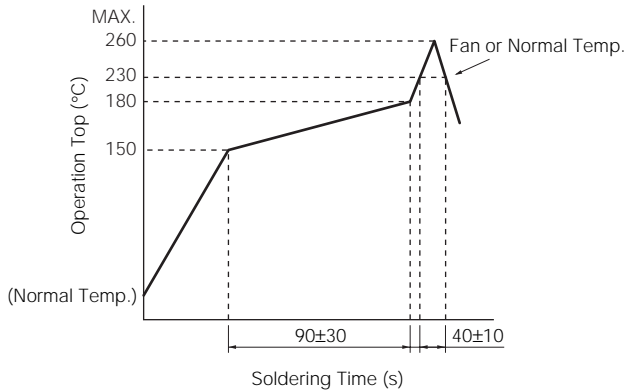

Embossed Carrier Taping

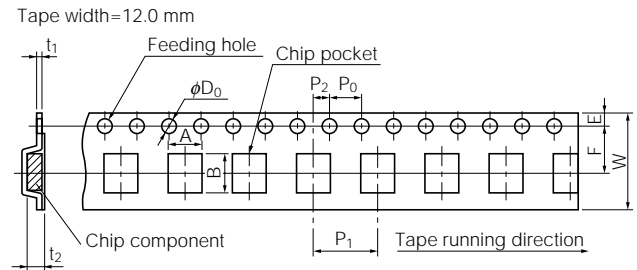

Unit: mm

Part No.	Height	A	B	W	F	E	P ₁	P ₂	P ₀	D ₀ Dia.	t ₁	t ₂
EVQQF	2.0	7.0±0.2	7.5±0.2	12.0±0.3	5.5±0.1	1.75±0.10	8.0±0.1	2.0±0.1	4.0±0.1	1.5 ^{+0.1} ₋₀	0.30±0.05	2.2±0.2

Standard Reel Dimensions in mm (not to scale)

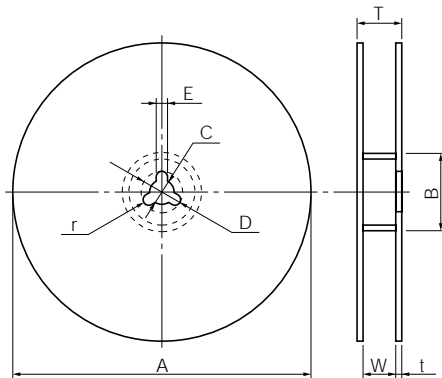

Item	A	B	C	D	E
Rate (mm)	φ370.0±2.0	φ50.0 min.	φ13.0±0.5	φ21.0±1.0	2.0±0.5

Item	W	T	t	r
Rate (mm)	14.0±1.5	—	1.0 to 3.0	1.0±0.5

Recommended Shape of Test Pole

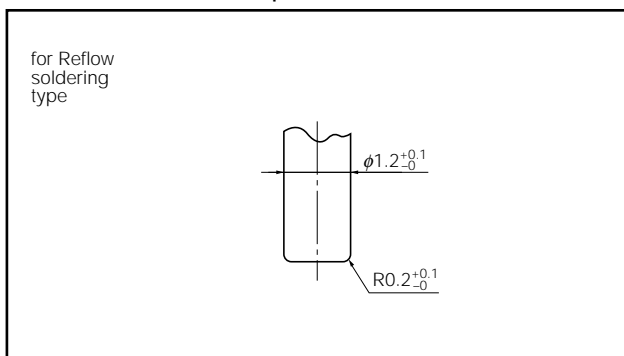

Recommended Operating Conditions

