

Excellent Integrated System Limited

Stocking Distributor

Click to view price, real time Inventory, Delivery & Lifecycle Information:

[Fairchild Semiconductor](#)
[74ACT16244SSC](#)

For any questions, you can email us directly:

sales@integrated-circuit.com



August 1999
 Revised May 2005

74AC16244 • 74ACT16244 16-Bit Buffer/Line Driver with 3-STATE Outputs

General Description

The AC16244 and ACT16244 contain sixteen non-inverting buffers with 3-STATE outputs designed to be employed as a memory and address driver, clock driver, or bus oriented transmitter/receiver. The device is nibble controlled. Each nibble has separate 3-STATE control inputs which can be shorted together for full 16-bit operation.

Features

- Separate control logic for each byte and nibble
- 16-bit version of the AC244/ACT244
- Outputs source/sink 24 mA
- ACT16244 has TTL-compatible inputs

Ordering Code:

Order Number	Package Number	Package Description
74AC16244SSC	MS48A	48-Lead Small Shrink Outline Package (SSOP), JEDEC MO-118, 0.300" Wide
74ACT16244SSC	MS48A	48-Lead Small Shrink Outline Package (SSOP), JEDEC MO-118, 0.300" Wide
74ACT16244MTD	MTD48	48-Lead Thin Shrink Small Outline Package (TSSOP), JEDEC MO-153, 6.1mm Wide

Device also available in Tape and Reel. Specify by appending suffix letter "X" to the ordering code.

Logic Symbol

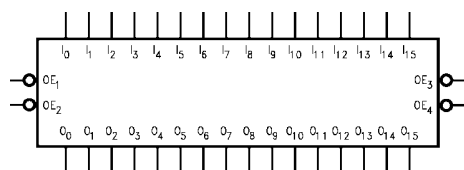

Connection Diagram

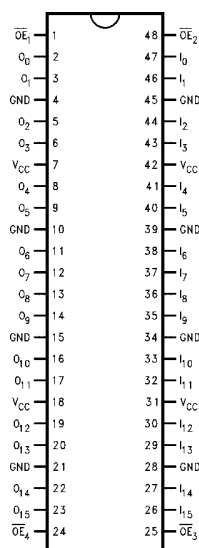

Pin Descriptions

Pin Names	Description
\overline{OE}_n	Output Enable Input (Active LOW)
$I_0 - I_{15}$	Inputs
$O_0 - O_{15}$	Outputs

FACT™ is a trademark of Fairchild Semiconductor Corporation.

74ACT16244 • 74ACT16244

Functional Description

The AC16244 and ACT16244 contain sixteen non-inverting buffers with 3-STATE standard outputs. The device is nibble (4 bits) controlled with each nibble functioning identically, but independent of the other. The control pins can be shorted together to obtain full 16-bit operation. The

3-STATE outputs are controlled by an Output Enable (\overline{OE}_n) input for each nibble. When \overline{OE}_n is LOW, the outputs are in 2-state mode. When \overline{OE}_n is HIGH, the outputs are in the high impedance mode, but this does not interfere with entering new data into the inputs.

Truth Tables

Inputs		Outputs
\overline{OE}_1	I ₀ -I ₃	O ₀ -O ₃
L	L	L
L	H	H
H	X	Z

Inputs		Outputs
\overline{OE}_2	I ₄ -I ₇	O ₄ -O ₇
L	L	L
L	H	H
H	X	Z

Inputs		Outputs
\overline{OE}_3	I ₈ -I ₁₁	O ₈ -O ₁₁
L	L	L
L	H	H
H	X	Z

Inputs		Outputs
\overline{OE}_4	I ₁₂ -I ₁₅	O ₁₂ -O ₁₅
L	L	L
L	H	H
H	X	Z

L = LOW Voltage Level
 H = HIGH Voltage Level

X = Immaterial
 Z = High Impedance

Logic Diagram

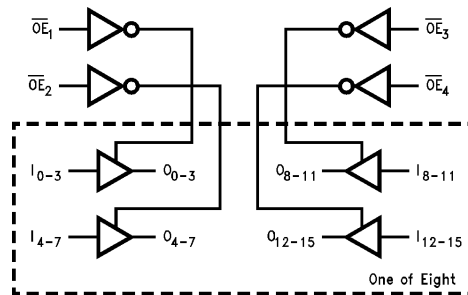

Absolute Maximum Ratings (Note 1)		Recommended Operating Conditions	
Supply Voltage (V_{CC})	-0.5V to +7.0V	Supply Voltage (V_{CC})	2.0V to 6.0V
DC Input Diode Current (I_{IK})		AC	4.5V to 5.5V
$V_I = -0.5V$	-20 mA	ACT	0V to V_{CC}
$V_I = V_{CC} + 0.5V$	+20 mA	Output Voltage (V_O)	0V to V_{CC}
DC Output Diode Current (I_{OK})		Operating Temperature (T_A)	-40°C to +85°C
$V_O = -0.5V$	-20 mA	Minimum Input Edge Rate ($\Delta V/\Delta t$)	
$V_O = V_{CC} + 0.5V$	+20 mA	AC Devices	
DC Output Voltage (V_O)	-0.5V to $V_{CC} + 0.5V$	V_{IN} from 30% to 70%	
DC Output Source/Sink Current (I_O)	± 50 mA	V_{CC} @ 3.3V, 4.5V, 5.5V	125 mV/ns
DC V_{CC} or Ground Current		Minimum Input Edge Rate ($\Delta V/\Delta t$)	
per Output Pin	± 50 mA	ACT Devices	
Junction Temperature	+140°C	V_{IN} from 0.8V to 2.0V	
Storage Temperature	-65°C to +150°C	V_{CC} @ 4.5V, 5.5V	125 mV/ns

Note 1: Absolute maximum ratings are those values beyond which damage to the device may occur. The databook specifications should be met, without exception to ensure that the system design is reliable over its power supply, temperature, and output/input loading variables. Fairchild does not recommend operation of FACT™ circuits outside databook specifications.

DC Electrical Characteristics for AC

Symbol	Parameter	V_{CC} (V)	$T_A = -25^\circ\text{C}$		$T_A = -40^\circ\text{C to } +85^\circ\text{C}$		Units	Conditions
			Typ	Guaranteed Limits				
V_{IH}	Minimum HIGH Input Voltage	3.0	1.5	2.1	2.1	V	$V_{OUT} = 0.1V$ or $V_{CC} - 0.1V$	
		4.5	2.25	3.15	3.15			
		5.5	2.75	3.85	3.85			
V_{IL}	Maximum LOW Input Voltage	3.0	1.5	0.9	0.9	V	$V_{OUT} = 0.1V$ or $V_{CC} - 0.1V$	
		4.5	2.25	1.35	1.35			
		5.5	2.75	1.65	1.65			
V_{OH}	Minimum HIGH Output Voltage	3.0	2.99	2.9	2.9	V	$I_{OUT} = -50 \mu A$	
		4.5	4.49	4.4	4.4			
		5.5	5.49	5.4	5.4			
		3.0		2.56	2.46	V	$I_{OH} = -12 \text{ mA}$ $I_{OH} = -24 \text{ mA}$ $I_{OH} = -24 \text{ mA (Note 2)}$	
		4.5		3.86	3.76			
5.5		4.86	4.76					
V_{OL}	Maximum LOW Output Voltage	3.0	0.002	0.1	0.1	V	$I_{OUT} = 50 \mu A$	
		4.5	0.001	0.1	0.1			
		5.5	0.001	0.1	0.1			
		3.0		0.36	0.44	V	$I_{OL} = 12 \text{ mA}$ $I_{OL} = 24 \text{ mA}$ $I_{OL} = 24 \text{ mA (Note 2)}$	
		4.5		0.36	0.44			
5.5		0.36	0.44					
I_{OZ}	Maximum 3-STATE Leakage Current	5.5		0.50	± 5.0	μA	V_I (OE) = V_{IL} , V_{IH} $V_I = V_{CC}$, GND $V_O = V_{CC}$, GND	
I_{IN}	Maximum Input Leakage Current (Note 3)	5.5		± 0.1	± 1.0	μA	$V_I = V_{CC}$, GND	
I_{CC}	Max Quiescent Supply Current (Note 3)	5.5		8.0	80.0	μA	$V_{IN} = V_{CC}$ or GND	
I_{OLD}	Minimum Dynamic	5.5			75	mA	$V_{OLD} = 1.65V$ Max	
I_{OHD}	Output Current (Note 4)	5.5			-75	mA	$V_{OHD} = 3.85V$ Min	

Note 2: All outputs loaded; thresholds associated with output under test.
Note 3: I_{IN} and I_{CC} @ 3.0V are guaranteed to be less than or equal to the respective limit @ 5.5V V_{CC} .
Note 4: Maximum test duration 2.0 millisecond; one output loaded at a time.

74ACT16244 • 74ACT16244

DC Electrical Characteristics for ACT							
Symbol	Parameter	V _{CC} (V)	T _A = +25°C		T _A = -40°C to +85°C	Units	Conditions
			Typ	Guaranteed Limits			
V _{IH}	Minimum HIGH Input Voltage	4.5	1.5	2.0	2.0	V	V _{OUT} = 0.1V or V _{CC} - 0.1V
		5.5	1.5	2.0	2.0		
V _{IL}	Maximum LOW Input Voltage	4.5	1.5	0.8	0.8	V	V _{OUT} = 0.1V or V _{CC} - 0.1V
		5.5	1.5	0.8	0.8		
V _{OH}	Minimum HIGH Output Voltage	4.5	4.49	4.4	4.4	V	I _{OUT} = -50 μA
		5.5	5.49	5.4	5.4		
		4.5		3.86	3.76	V	V _{IN} = V _{IL} or V _{IH} I _{OH} = -24 mA I _{OH} = -24 mA (Note 5)
		5.5		4.86	4.76		
V _{OL}	Maximum LOW Output Voltage	4.5	0.001	0.1	0.1	V	I _{OUT} = 50 μA
		5.5	0.001	0.1	0.1		
		4.5		0.36	0.44	V	V _{IN} = V _{IL} or V _{IH} I _{OH} = 24 mA I _{OH} = 24 mA (Note 5)
		5.5		0.36	0.44		
I _{OZ}	Maximum 3-STATE Leakage Current	5.5		± 0.5	± 5.0	μA	V _I = V _{IL} , V _{IH} V _O = V _{CC} , GND
I _{IN}	Maximum Input Leakage Current	5.5		± 0.1	± 1.0	μA	V _I = V _{CC} , GND
I _{CCT}	Maximum I _{CC} /Input	5.5	0.6		1.5	mA	V _I = V _{CC} - 2.1V
I _{CC}	Max Quiescent Supply Current	5.5		8.0	80.0	μA	V _{IN} = V _{CC} or GND
I _{OLD}	Minimum Dynamic	5.5			75	mA	V _{OLD} = 1.65V Max
I _{OHD}	Output Current (Note 6)				-75	mA	V _{OHD} = 3.85V Min

Note 5: All outputs loaded; thresholds associated with output under test.
Note 6: Maximum test duration 2.0 millisecond; one output loaded at a time.

AC Electrical Characteristics for AC								
Symbol	Parameter	V _{CC} (V) (Note 7)	T _A = +25°C C _L = 50 pF			T _A = -40°C to +85°C C _L = 50 pF		Units
			Min	Typ	Max	Min	Max	
t _{PLH}	Propagation Delay	3.3	2.0	6.3	9.4	2.0	10.8	ns
	Data to Output	5.0	1.6	4.6	6.5	1.6	7.1	
t _{PHL}	Propagation Delay	3.3	2.4	5.7	10.7	2.4	11.8	ns
	Data to Output	5.0	2.0	4.3	7.0	2.0	7.9	
t _{PZH}	Output Enable Time	3.3	2.2	6.2	10	2.2	11.5	ns
		5.0	1.7	4.6	6.7	1.7	7.5	
t _{PZL}	Output Enable Time	3.3	2.9	6.4	13.0	2.9	14.6	ns
		5.0	2.2	4.7	8.1	2.2	9.0	
t _{PHZ}	Output Disable Time	3.3	3.1	5.5	8.4	3.1	9.1	ns
		5.0	1.9	3.9	7.8	1.9	8.4	
t _{PLZ}	Output Disable Time	3.3	2.4	4.7	8.1	2.4	8.8	ns
		5.0	1.7	3.6	7.2	1.7	7.6	

Note 7: Voltage Range 5.0 is 5.0V ± 0.5V.
 Voltage Range 3.3 is 3.3V ± 0.3V.

AC Electrical Characteristics for ACT								
Symbol	Parameter	V _{CC} (V) (Note 8)	T _A = +25°C C _L = 50 pF			T _A = -40°C to +85°C C _L = 50 pF		Units
			Min	Typ	Max	Min	Max	
t _{PLH}	Propagation Delay	5.0	3.0	5.2	7.3	3.0	7.8	ns
t _{PHL}	Data to Output		2.5	4.8	6.8	2.5	7.3	
t _{PZH}	Output Enable	5.0	2.5	5.0	7.4	2.5	7.9	ns
t _{PZL}	Time		2.7	4.6	7.5	2.7	8.0	
t _{PHZ}	Output Disable	5.0	2.3	5.0	7.9	2.3	8.2	ns
t _{PLZ}	Time		2.0	4.6	7.4	2.0	7.9	

Note 8: Voltage Range 5.0 is 5.0V ± 0.5V.

Capacitance					
Symbol	Parameter	Typ	Units	Conditions	
C _{IN}	Input Pin Capacitance	4.5	pF	V _{CC} = 5.0V	
C _{OUT}	Output Pin Capacitance	12	pF	V _{CC} = 5.0V	
C _{PD}	Power Dissipation Capacitance	74AC16244	35	pF	V _{CC} = 5.0V
		74ACT16244	30		

74ACT16244 • 74ACT16244

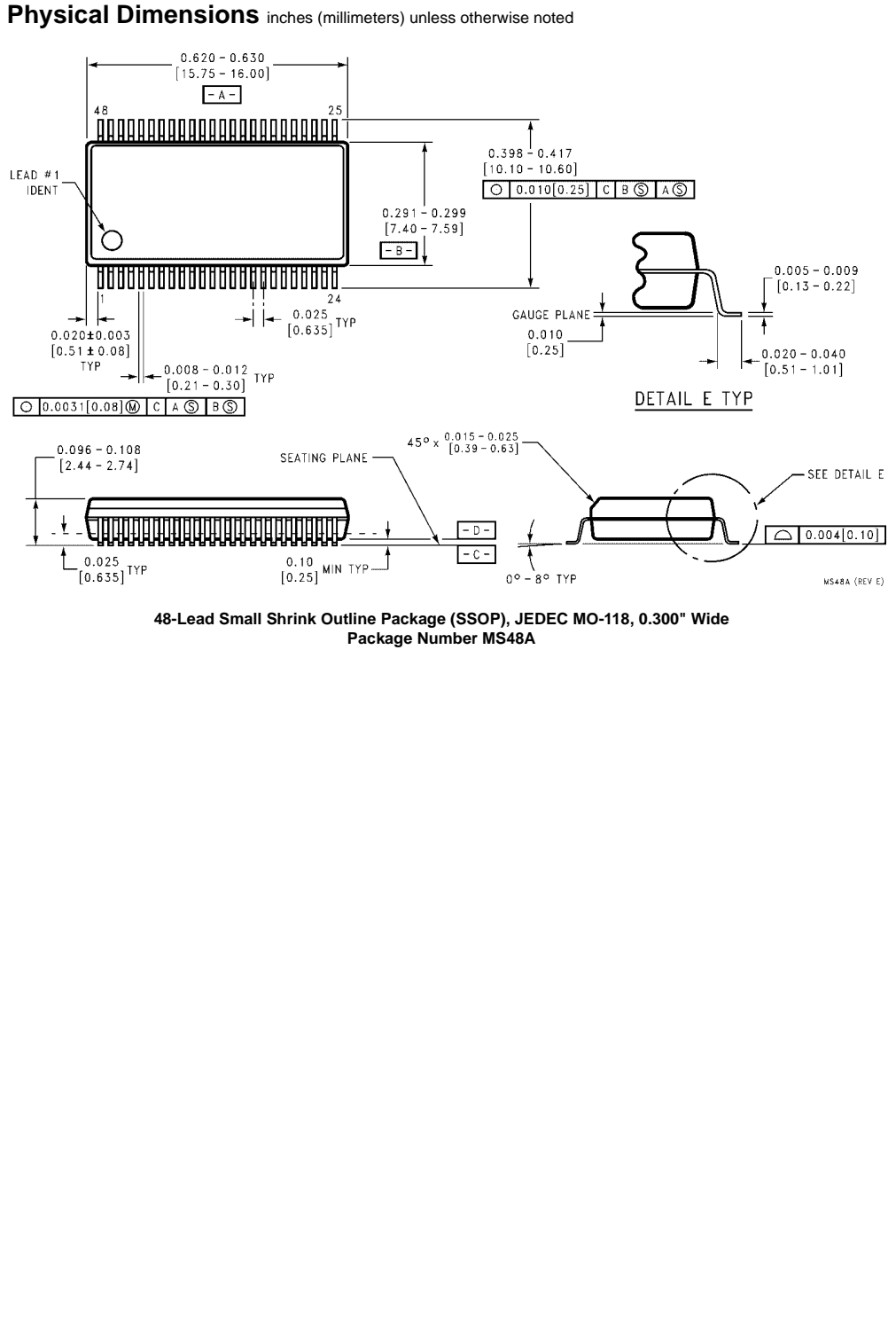

Physical Dimensions inches (millimeters) unless otherwise noted (Continued)

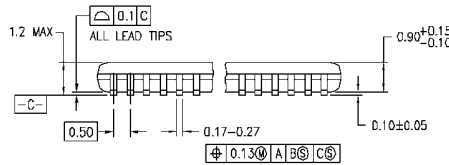
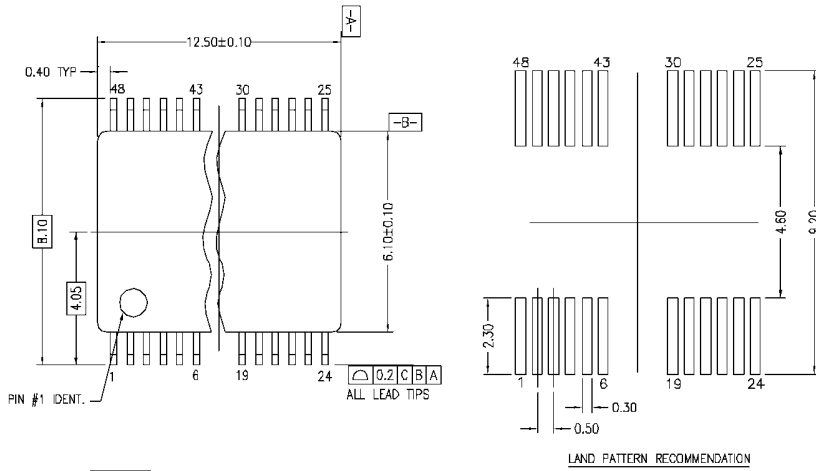

DIMENSIONS ARE IN MILLIMETERS

NOTES:

- A. CONFORMS TO JEDEC REGISTRATION MO-153, VARIATION ED, DATE 4/97.
- B. DIMENSIONS ARE IN MILLIMETERS.
- C. DIMENSIONS ARE EXCLUSIVE OF BURRS, MOLD FLASH, AND TIE BAR EXTRUSIONS.
- D. DIMENSIONS AND TOLERANCES PER ANSI Y14.5M, 1982.

MTD48REVC

48-Lead Thin Shrink Small Outline Package (TSSOP), JEDEC MO-153, 6.1mm Wide Package Number MTD48

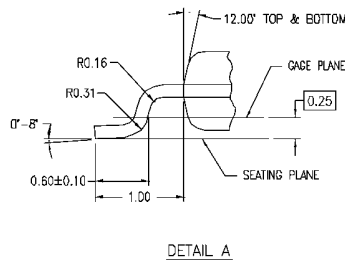

Fairchild does not assume any responsibility for use of any circuitry described, no circuit patent licenses are implied and Fairchild reserves the right at any time without notice to change said circuitry and specifications.

LIFE SUPPORT POLICY

FAIRCHILD'S PRODUCTS ARE NOT AUTHORIZED FOR USE AS CRITICAL COMPONENTS IN LIFE SUPPORT DEVICES OR SYSTEMS WITHOUT THE EXPRESS WRITTEN APPROVAL OF THE PRESIDENT OF FAIRCHILD SEMICONDUCTOR CORPORATION. As used herein:

1. Life support devices or systems are devices or systems which, (a) are intended for surgical implant into the body, or (b) support or sustain life, and (c) whose failure to perform when properly used in accordance with instructions for use provided in the labeling, can be reasonably expected to result in a significant injury to the user.
2. A critical component in any component of a life support device or system whose failure to perform can be reasonably expected to cause the failure of the life support device or system, or to affect its safety or effectiveness.

www.fairchildsemi.com