

# FDT3612

## 100V N-Channel PowerTrench® MOSFET

### General Description

This N-Channel MOSFET has been designed specifically to improve the overall efficiency of DC/DC converters using either synchronous or conventional switching PWM controllers.

These MOSFETs feature faster switching and lower gate charge than other MOSFETs with comparable  $R_{DS(ON)}$  specifications. The result is a MOSFET that is easy and safer to drive (even at very high frequencies), and DC/DC power supply designs with higher overall efficiency.

### Applications

- DC/DC converter
- Motor driving

### Features

- 3.7 A, 100 V.  $R_{DS(ON)} = 120 \text{ m}\Omega @ V_{GS} = 10 \text{ V}$   
 $R_{DS(ON)} = 130 \text{ m}\Omega @ V_{GS} = 6 \text{ V}$
- Fast switching speed
- Low gate charge (14nC typ)
- High performance trench technology for extremely low  $R_{DS(ON)}$
- High power and current handling capability in a widely used surface mount package

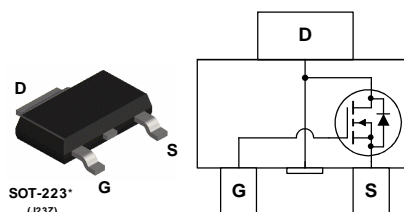
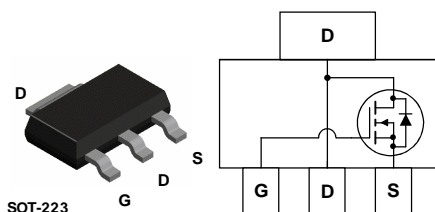

### Absolute Maximum Ratings $T_A=25^\circ\text{C}$ unless otherwise noted

| Symbol         | Parameter  | Rated         | Units            |
|----------------|--|---------------|------------------|
| $V_{DSS}$      | Drain-Source Voltage                             | 100           | V                |
| $V_{GSS}$      | Gate-Source Voltage                              | $\pm 20$      | V                |
| $I_D$          | Drain Current – Continuous (Note 1a)             | 3.7           | A                |
|                | – Pulsed   | 20            |                  |
| $P_D$          | Maximum Power Dissipation (Note 1a)              | 3.0           | W                |
|                |  | 1.3 (Note 1b) |                  |
|                |  | 1.1 (Note 1c) |                  |
| $T_J, T_{STG}$ | Operating and Storage Junction Temperature Range | -55 to +150   | $^\circ\text{C}$ |

### Thermal Characteristics

|                 |   |    |                    |
|-----------------|---|----|--------------------|
| $R_{\theta JA}$ | Thermal Resistance, Junction-to-Ambient (Note 1a) | 42 | $^\circ\text{C/W}$ |
| $R_{\theta JC}$ | Thermal Resistance, Junction-to-Case (Note 1)     | 12 | $^\circ\text{C/W}$ |

### Package Marking and Ordering Information

| Device Marking | Device  | Reel Size | Tape width | Quantity   |
|----------------|---------|-----------|------------|------------|
| 3612           | FDT3612 | 13"       | 12mm       | 2500 units |

## Electrical Characteristics

$T_A = 25^\circ\text{C}$  unless otherwise noted

| Symbol | Parameter | Test Conditions | Min | Typ | Max | Units |
|--------|-----------|-----------------|-----|-----|-----|-------|
|--------|-----------|-----------------|-----|-----|-----|-------|

### Drain-Source Avalanche Ratings (Note 2)

|           |                                |   |  |  |     |    |
|-----------|--------------------------------|---|--|--|-----|----|
| $W_{DSS}$ | Drain-Source Avalanche Energy  | Single Pulse, $V_{DD} = 50\text{ V}$ , $I_D = 3.7\text{ A}$ |  |  | 90  | mJ |
| $I_{AR}$  | Drain-Source Avalanche Current |   |  |  | 3.7 | A  |

### Off Characteristics

|                                      |   |   |     |     |      |                      |
|--------------------------------------|---|---|-----|-----|------|----------------------|
| $BV_{DSS}$                           | Drain-Source Breakdown Voltage            | $V_{GS} = 0\text{ V}$ , $I_D = 250\text{ }\mu\text{A}$            | 100 |     |      | V                    |
| $\frac{\Delta BV_{DSS}}{\Delta T_J}$ | Breakdown Voltage Temperature Coefficient | $I_D = 250\text{ }\mu\text{A}$ , Referenced to $25^\circ\text{C}$ |     | 106 |      | mV/ $^\circ\text{C}$ |
| $I_{DSS}$                            | Zero Gate Voltage Drain Current           | $V_{DS} = 80\text{ V}$ , $V_{GS} = 0\text{ V}$                    |     |     | 10   | $\mu\text{A}$        |
| $I_{GSSF}$                           | Gate-Body Leakage, Forward                | $V_{GS} = 20\text{ V}$ , $V_{DS} = 0\text{ V}$                    |     |     | 100  | nA                   |
| $I_{GSSR}$                           | Gate-Body Leakage, Reverse                | $V_{GS} = -20\text{ V}$ , $V_{DS} = 0\text{ V}$                   |     |     | -100 | nA                   |

### On Characteristics (Note 2)

|  |  |  |    |                 |                   |                      |
|--|--|--|----|-----------------|-------------------|----------------------|
| $V_{GS(th)}$                           | Gate Threshold Voltage                         | $V_{DS} = V_{GS}$ , $I_D = 250\text{ }\mu\text{A}$   | 2  | 2.5             | 4                 | V                    |
| $\frac{\Delta V_{GS(th)}}{\Delta T_J}$ | Gate Threshold Voltage Temperature Coefficient | $I_D = 250\text{ }\mu\text{A}$ , Referenced to $25^\circ\text{C}$  |    | -6              |                   | mV/ $^\circ\text{C}$ |
| $R_{DS(on)}$                           | Static Drain-Source On-Resistance              | $V_{GS} = 10\text{ V}$ , $I_D = 3.7\text{ A}$<br>$V_{GS} = 6\text{ V}$ , $I_D = 3.5\text{ A}$<br>$V_{GS} = 10\text{ V}$ , $I_D = 3.7\text{ A}$ , $T_J = 125^\circ\text{C}$ |    | 88<br>94<br>170 | 120<br>130<br>245 | m $\Omega$           |
| $I_{D(on)}$                            | On-State Drain Current                         | $V_{GS} = 10\text{ V}$ , $V_{DS} = 10\text{ V}$  | 10 |                 |                   | A                    |
| $g_{FS}$                               | Forward Transconductance                       | $V_{DS} = 10\text{ V}$ , $I_D = 3.7\text{ A}$  |    | 11              |                   | S                    |

### Dynamic Characteristics

|           |                              |  |  |     |  |    |
|-----------|------------------------------|--|--|-----|--|----|
| $C_{iss}$ | Input Capacitance            | $V_{DS} = 50\text{ V}$ , $V_{GS} = 0\text{ V}$ ,<br>$f = 1.0\text{ MHz}$ |  | 632 |  | pF |
| $C_{oss}$ | Output Capacitance           |  |  | 40  |  | pF |
| $C_{rss}$ | Reverse Transfer Capacitance |  |  | 20  |  | pF |

### Switching Characteristics (Note 2)

|              |                     |   |  |     |    |    |
|--------------|---------------------|---|--|-----|----|----|
| $t_{d(on)}$  | Turn-On Delay Time  | $V_{DD} = 50\text{ V}$ , $I_D = 1\text{ A}$ ,<br>$V_{GS} = 10\text{ V}$ , $R_{GEN} = 6\text{ }\Omega$ |  | 8.5 | 17 | ns |
| $t_r$        | Turn-On Rise Time   |   |  | 2   | 4  | ns |
| $t_{d(off)}$ | Turn-Off Delay Time |   |  | 23  | 37 | ns |
| $t_f$        | Turn-Off Fall Time  |   |  | 4.5 | 9  | ns |
| $Q_g$        | Total Gate Charge   | $V_{DS} = 50\text{ V}$ , $I_D = 3.7\text{ A}$ ,<br>$V_{GS} = 10\text{ V}$                             |  | 14  | 20 | nC |
| $Q_{gs}$     | Gate-Source Charge  |   |  | 2.4 |    | nC |
| $Q_{gd}$     | Gate-Drain Charge   |   |  | 3.8 |    | nC |

### Drain-Source Diode Characteristics and Maximum Ratings

|          |   |   |  |      |     |   |
|----------|---|---|--|------|-----|---|
| $I_S$    | Maximum Continuous Drain-Source Diode Forward Current |   |  | 2.5  | A   |   |
| $V_{SD}$ | Drain-Source Diode Forward Voltage                    | $V_{GS} = 0\text{ V}$ , $I_S = 2.5\text{ A}$ (Note 2) |  | 0.75 | 1.2 | V |

#### Notes:

1.  $R_{\theta JA}$  is the sum of the junction-to-case and case-to-ambient thermal resistance where the case thermal reference is defined as the solder mounting surface of the drain pins.  $R_{\theta JC}$  is guaranteed by design while  $R_{\theta CA}$  is determined by the user's board design.



a)  $42^\circ\text{C/W}$  when mounted on a  $1\text{ in}^2$  pad of 2 oz copper



b)  $95^\circ\text{C/W}$  when mounted on a  $.0066\text{ in}^2$  pad of 2 oz copper



c)  $110^\circ\text{C/W}$  when mounted on a minimum pad.

2. Pulse Test: Pulse Width <  $300\mu\text{s}$ , Duty Cycle < 2.0%

### Typical Characteristics

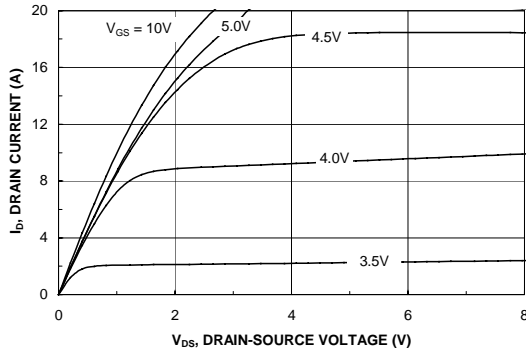

Figure 1. On-Region Characteristics.

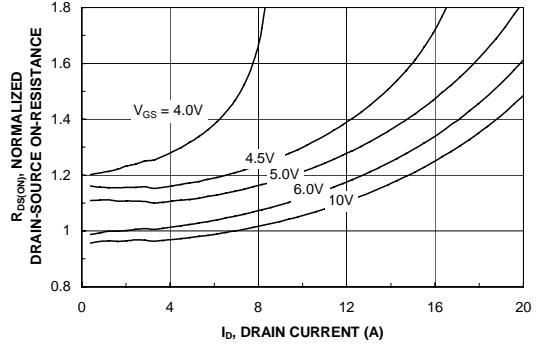

Figure 2. On-Resistance Variation with Drain Current and Gate Voltage.

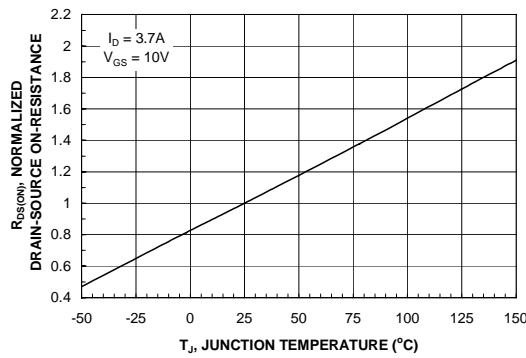

Figure 3. On-Resistance Variation with Temperature.

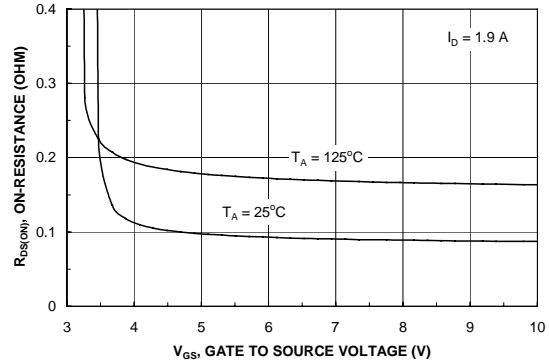

Figure 4. On-Resistance Variation with Gate-to-Source Voltage.

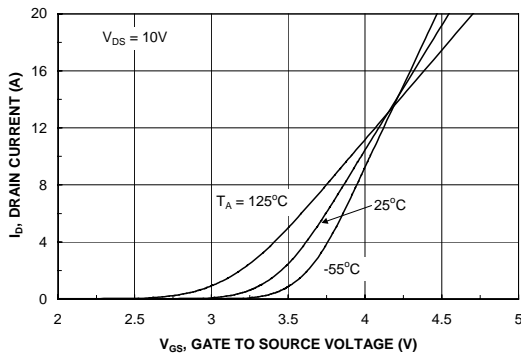

Figure 5. Transfer Characteristics.

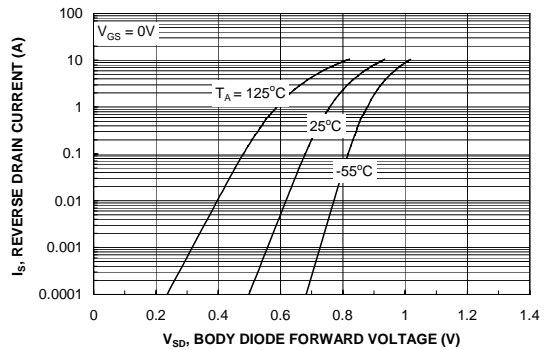

Figure 6. Body Diode Forward Voltage Variation with Source Current and Temperature.

### Typical Characteristics

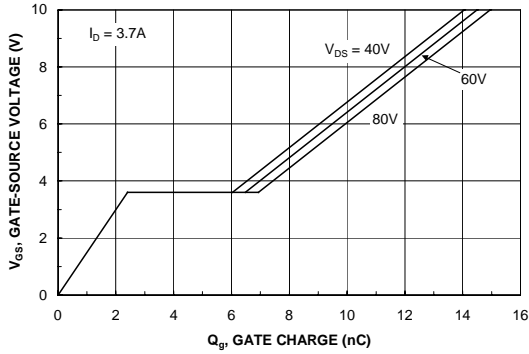

Figure 7. Gate Charge Characteristics.

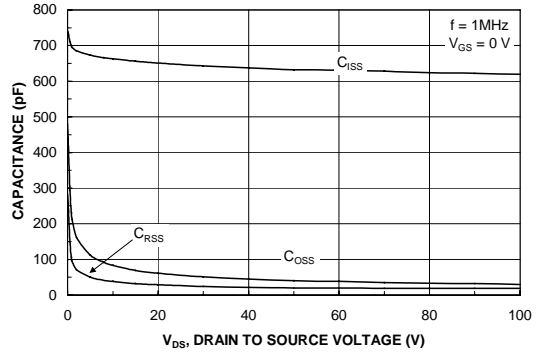

Figure 8. Capacitance Characteristics.

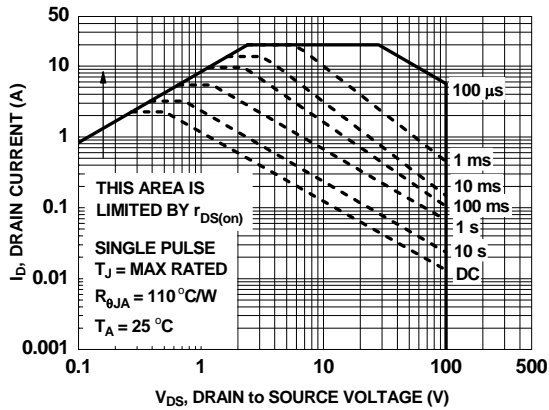

Figure 9. Maximum Safe Operating Area.

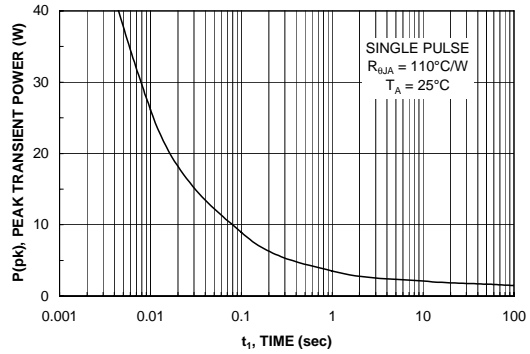

Figure 10. Single Pulse Maximum Power Dissipation.

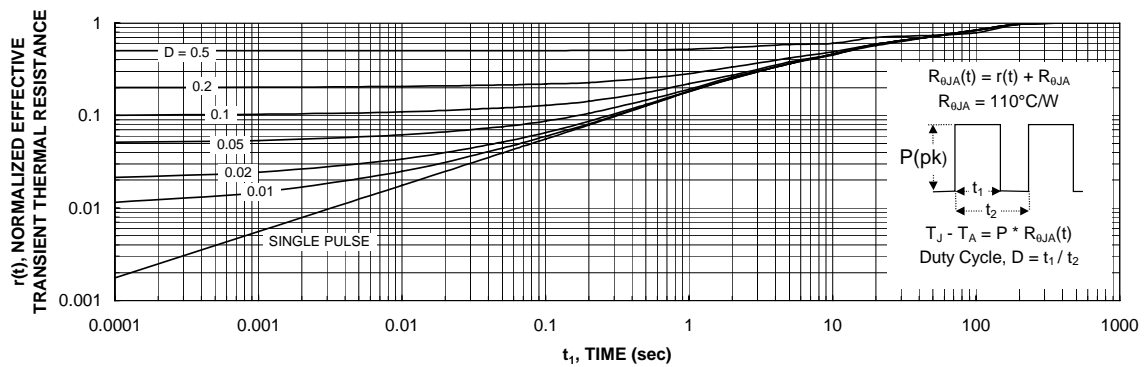
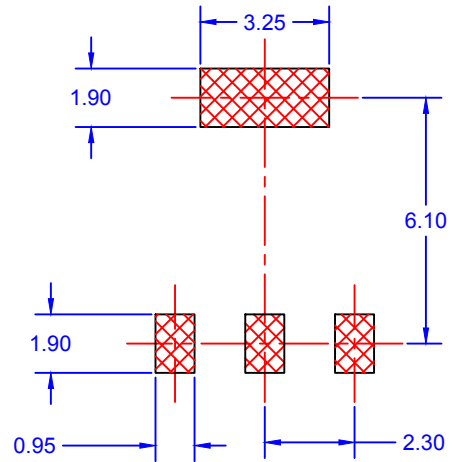
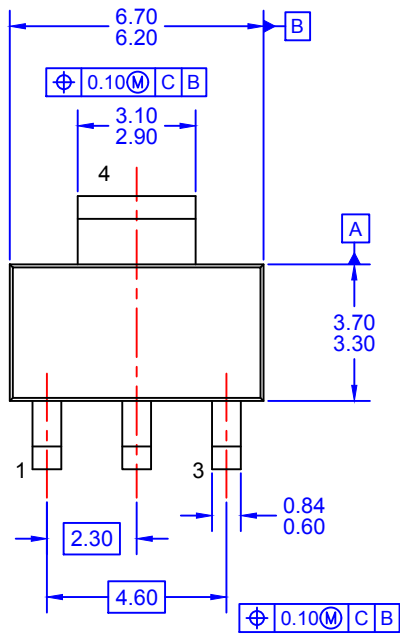
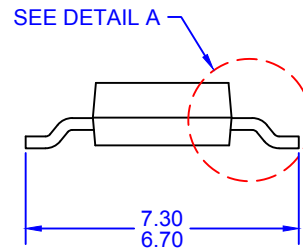
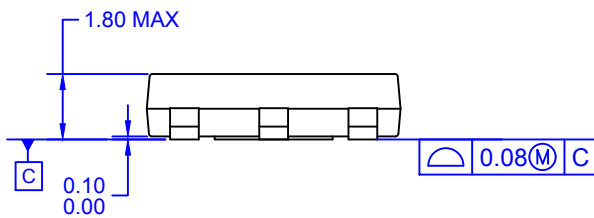

Figure 11. Transient Thermal Response Curve.

Thermal characterization performed using the conditions described in Note 1c. Transient thermal response will change depending on the circuit board design.



LAND PATTERN RECOMMENDATION



- NOTES: UNLESS OTHERWISE SPECIFIED  
 A) DRAWING BASED ON JEDEC REGISTRATION TO-261C, VARIATION AA.  
 B) ALL DIMENSIONS ARE IN MILLIMETERS.  
 C) DIMENSIONS DO NOT INCLUDE BURRS OR MOLD FLASH. MOLD FLASH OR BURRS DOES NOT EXCEED 0.10MM.  
 D) DIMENSIONING AND TOLERANCING PER ASME Y14.5M-2009.  
 E) LANDPATTERN NAME: SOT230P700X180-4BN  
 F) DRAWING FILENAME: MKT-MA04AREV3

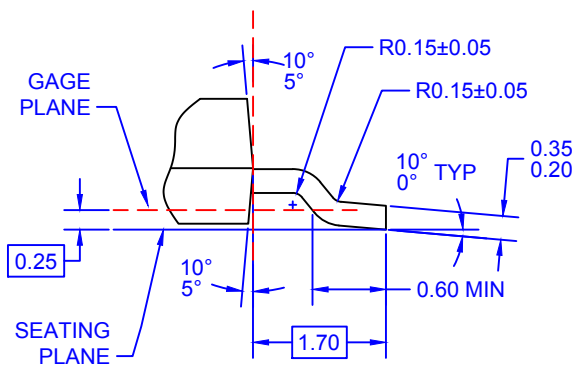

DETAIL A  
 SCALE: 2:1





**TRADEMARKS**

The following includes registered and unregistered trademarks and service marks, owned by Fairchild Semiconductor and/or its global subsidiaries, and is not intended to be an exhaustive list of all such trademarks.

- |                          |  |                                       |                  |
|--------------------------|--|---------------------------------------|------------------|
| AccuPower™               | F-PFS™   | OPTOPLANAR®                           | SYSTEM GENERAL®  |
| AttitudeEngine™          | FRFET®   | Power Supply WebDesigner™             | TinyBoost®       |
| Awinda®                  | Global Power Resource <sup>SM</sup>            | PowerTrench®                          | TinyBuck®        |
| AX-CAP®*                 | GreenBridge™                                   | PowerXS™                              | TinyCalc™        |
| BitSiC™                  | Green FPS™                                     | Programmable Active Droop™            | TinyLogic®       |
| Build it Now™            | Green FPS™ e-Series™                           | QFET®                                 | TINYOPTO™        |
| CorePLUS™                | Gmax™  | QS™                                   | TinyPower™       |
| CorePOWER™               | GTO™   | Quiet Series™                         | TinyPWM™         |
| CROSSVOLT™               | IntelliMAX™                                    | RapidConfigure™                       | TinyWire™        |
| CTL™                     | ISOPLANAR™                                     | Saving our world, 1mW/W/kW at a time™ | TranSiC™         |
| Current Transfer Logic™  | Making Small Speakers Sound Louder and Better™ | SignalWise™                           | TriFault Detect™ |
| DEUXPEED®                | MegaBuck™                                      | SmartMax™                             | TRUECURRENT®*    |
| Dual Cool™               | MICROCOUPLER™                                  | SMART START™                          | μSerDes™         |
| EcoSPARK®                | MicroFET™                                      | Solutions for Your Success™           | UHC®             |
| EfficientMax™            | MicroPak™                                      | SPM®                                  | Ultra FRFET™     |
| ESBC™                    | MicroPak2™                                     | STEALTH™                              | UniFET™          |
| F <sup>®</sup>           | MillerDrive™                                   | SuperFET®                             | VCX™             |
| Fairchild®               | MotionMax™                                     | SuperSOT™-3                           | VisualMax™       |
| Fairchild Semiconductor® | MotionGrid®                                    | SuperSOT™-6                           | VoltagePlus™     |
| FACT Quiet Series™       | MTi®   | SuperSOT™-8                           | XST™             |
| FACT®                    | MTx®   | SupreMOS®                             | Xsens™           |
| FastvCore™               | MVN®   | SyncFET™                              | 仙童®              |
| FETBench™                | mWSaver®                                       | Sync-Lock™                            |                  |
| FPS™                     | OptoHiT™                                       |                                       |                  |
|                          | OPTOLOGIC®                                     |                                       |                  |

\* Trademarks of System General Corporation, used under license by Fairchild Semiconductor.

**DISCLAIMER**

FAIRCHILD SEMICONDUCTOR RESERVES THE RIGHT TO MAKE CHANGES WITHOUT FURTHER NOTICE TO ANY PRODUCTS HEREIN TO IMPROVE RELIABILITY, FUNCTION, OR DESIGN. TO OBTAIN THE LATEST, MOST UP-TO-DATE DATASHEET AND PRODUCT INFORMATION, VISIT OUR WEBSITE AT [HTTP://WWW.FAIRCHILDSEMI.COM](http://www.fairchildsemi.com). FAIRCHILD DOES NOT ASSUME ANY LIABILITY ARISING OUT OF THE APPLICATION OR USE OF ANY PRODUCT OR CIRCUIT DESCRIBED HEREIN; NEITHER DOES IT CONVEY ANY LICENSE UNDER ITS PATENT RIGHTS, NOR THE RIGHTS OF OTHERS. THESE SPECIFICATIONS DO NOT EXPAND THE TERMS OF FAIRCHILD'S WORLDWIDE TERMS AND CONDITIONS, SPECIFICALLY THE WARRANTY THEREIN, WHICH COVERS THESE PRODUCTS.

**AUTHORIZED USE**

Unless otherwise specified in this data sheet, this product is a standard commercial product and is not intended for use in applications that require extraordinary levels of quality and reliability. This product may not be used in the following applications, unless specifically approved in writing by a Fairchild officer: (1) automotive or other transportation, (2) military/aerospace, (3) any safety critical application – including life critical medical equipment – where the failure of the Fairchild product reasonably would be expected to result in personal injury, death or property damage. Customer's use of this product is subject to agreement of this Authorized Use policy. In the event of an unauthorized use of Fairchild's product, Fairchild accepts no liability in the event of product failure. In other respects, this product shall be subject to Fairchild's Worldwide Terms and Conditions of Sale, unless a separate agreement has been signed by both Parties.

**ANTI-COUNTERFEITING POLICY**

Fairchild Semiconductor Corporation's Anti-Counterfeiting Policy. Fairchild's Anti-Counterfeiting Policy is also stated on our external website, [www.fairchildsemi.com](http://www.fairchildsemi.com), under Terms of Use

Counterfeiting of semiconductor parts is a growing problem in the industry. All manufacturers of semiconductor products are experiencing counterfeiting of their parts. Customers who inadvertently purchase counterfeit parts experience many problems such as loss of brand reputation, substandard performance, failed applications, and increased cost of production and manufacturing delays. Fairchild is taking strong measures to protect ourselves and our customers from the proliferation of counterfeit parts. Fairchild strongly encourages customers to purchase Fairchild parts either directly from Fairchild or from Authorized Fairchild Distributors who are listed by country on our web page cited above. Products customers buy either from Fairchild directly or from Authorized Fairchild Distributors are genuine parts, have full traceability, meet Fairchild's quality standards for handling and storage and provide access to Fairchild's full range of up-to-date technical and product information. Fairchild and our Authorized Distributors will stand behind all warranties and will appropriately address any warranty issues that may arise. Fairchild will not provide any warranty coverage or other assistance for parts bought from Unauthorized Sources. Fairchild is committed to combat this global problem and encourage our customers to do their part in stopping this practice by buying direct or from authorized distributors.

**PRODUCT STATUS DEFINITIONS**

**Definition of Terms**

| Datasheet Identification | Product Status        | Definition  |
|--------------------------|-----------------------|---|
| Advance Information      | Formative / In Design | Datasheet contains the design specifications for product development. Specifications may change in any manner without notice.   |
| Preliminary              | First Production      | Datasheet contains preliminary data; supplementary data will be published at a later date. Fairchild Semiconductor reserves the right to make changes at any time without notice to improve design. |
| No Identification Needed | Full Production       | Datasheet contains final specifications. Fairchild Semiconductor reserves the right to make changes at any time without notice to improve the design.   |
| Obsolete                 | Not In Production     | Datasheet contains specifications on a product that is discontinued by Fairchild Semiconductor. The datasheet is for reference information only.  |

Rev. I77