

Excellent Integrated System Limited

Stocking Distributor

Click to view price, real time Inventory, Delivery & Lifecycle Information:

[Diodes Incorporated](#)
[ZXRE125FRSTOA](#)

For any questions, you can email us directly:

sales@integrated-circuit.com

ZXRE125

SOT23 MICROPOWER 1.22V VOLTAGE REFERENCE

SUMMARY

DESCRIPTION

The ZXRE125 is a bandgap circuit designed to achieve a precision micropower voltage reference of 1.22 volts. The device is available in the small outline SOT23 surface mount package which is ideal for applications where space saving is important.

SOT23 tolerance is available to 0.5% for precision applications. Excellent performance is maintained over the 8 μ A to 20mA operating current range with a typical temperature coefficient of only 20ppm/ $^{\circ}$ C. The device has been designed to be highly tolerant of capacitive loads so maintaining excellent stability.

This device offers a SOT23 pin for pin compatible replacement of the ZRA124 and ZRA125 series of voltage references. An E-Line (TO92 style) package is also available.

FEATURES

- High performance 1.220V reference
- 0.5%, 1%, 2% and 3% tolerance
- 4 μ A knee current
- 20ppm/ $^{\circ}$ C typical temperature coefficient
- Unconditionally stable
- Small outline SOT23

APPLICATIONS

- Battery powered equipment
- Precision power supplies
- Portable instrumentation
- Portable communications devices
- Data acquisition systems

ORDERING INFORMATION

DEVICE	TOL%	GRADE	PACKAGE	PARTMARKING	REEL	QUANTITY PER REEL
ZXRE125CFTA	0.5	C	SOT23	12J	7"	3,000
ZXRE125DFTA	1	D	SOT23	12H	7"	3,000
ZXRE125EFTA	2	E	SOT23	12G	7"	3,000
ZXRE125FFTA	3	F	SOT23	12F	7"	3,000
ZXRE125DRSTOA	1		E-line	ZXRE125D	-	2,000
ZXRE125ERSTOA	2		E-line	ZXRE125E	-	2,000
ZXRE125FRSTOA	3		E-line	ZXRE125F	-	2,000

NOTE:

E-line parts available loose in boxes of 2,000 units, omit "STOA" from order code i.e. ZXRE125DR

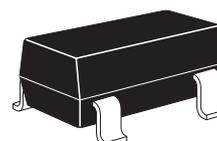

SOT23



E-line

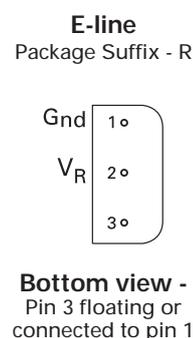
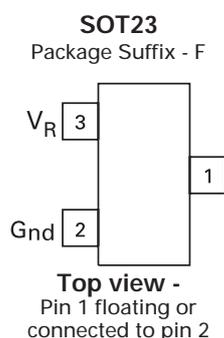

ZXRE125

ABSOLUTE MAXIMUM RATINGS

PARAMETER	SYMBOL	LIMIT	UNIT
Reverse current	V_Z	30	mA
Forward current		10	mA
Operating temperature	T_{OMP}	-40 to 85	°C
Storage temperature	T_{STG}	-55 to 125	°C

POWER DISSIPATION (at $T_{amb} = 25^{\circ}C$, $T_{jmax} = 25^{\circ}C$)

PACKAGE	VALUE	UNIT
SOT23	330	mW
E-line	500	mW

ZXRE125

SCHEMATIC DIAGRAM

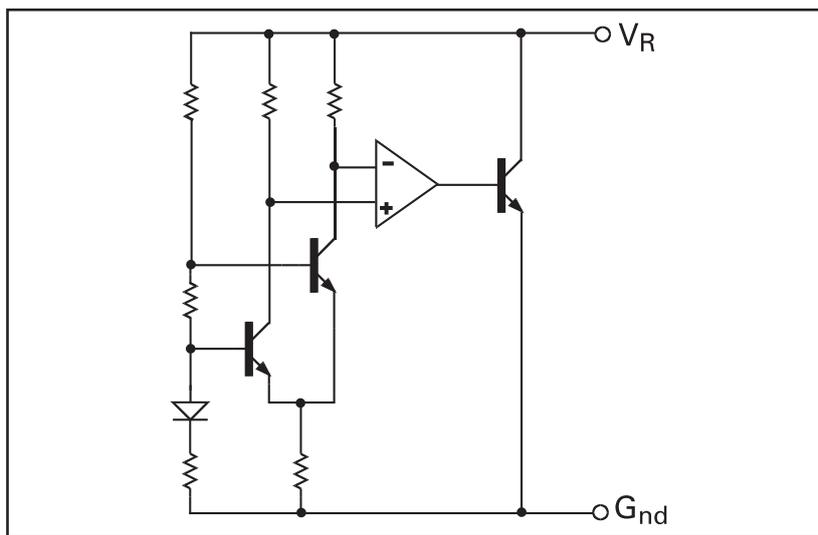

APPLICATIONS CIRCUIT

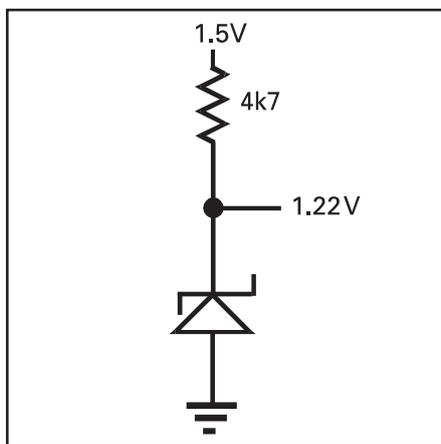

ZXRE125

ELECTRICAL CHARACTERISTICS (at $T_{amb} = 25^{\circ}\text{C}$ unless otherwise stated)

PARAMETER	SYMBOL	CONDITIONS	MIN.	TYP.	MAX.	GRADE/ TOL%	UNITS
Reverse Breakdown Voltage	V_R	$I_R = 100\mu\text{A}$	1.214	1.220	1.226	C/0.5 ⁽¹⁾	V
			1.208	1.220	1.232	D/1	V
			1.196	1.220	1.244	E/2	V
			1.183	1.220	1.257	F/3	V
Minimum Knee Current	I_{MIN}		4	8		μA	
Recommended Operating Current Range	I_R		0.008	20		mA	
Average Reverse Breakdown Voltage Temperature Coefficient	T_C ⁽²⁾	$I_{R(min)}$ to $I_{R(max)}$		20	75		ppm/ $^{\circ}\text{C}$
Reverse Breakdown Change with Current Voltage	$\frac{\Delta V_R}{\Delta I_R}$	$I_R = 30\mu\text{A}$ to 1 mA $I_R = 1\text{mA}$ to 5mA			1		mV
					10		mV
Reverse Dynamic Impedance	Z_R	$I_R = 1\text{mA}$ $f = 100\text{Hz}$ $I_{AC} = 0.1I_R$		0.2	0.6		Ω
Wideband Noise Voltage	E_N	$I_R = 8\mu\text{A}$ to 100 μA $f = 10\text{Hz}$ to 10kHz		60			$\mu\text{V(rms)}$

NOTE:

(1) 0.5% SOT23 only

$$(2) T_C = \frac{(V_{R(max)} - V_{R(min)}) \times 1000000}{V_R \times (T_{(max)} - T_{(min)})}$$

$V_{R(max)} - V_{R(min)}$ is the maximum deviation in reference voltage measured over the full operating temperature range

REVERSE CHARACTERISTICS

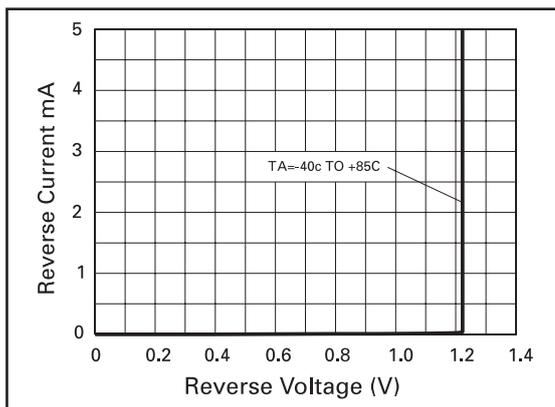

ZXRE125

TYPICAL CHARACTERISTICS

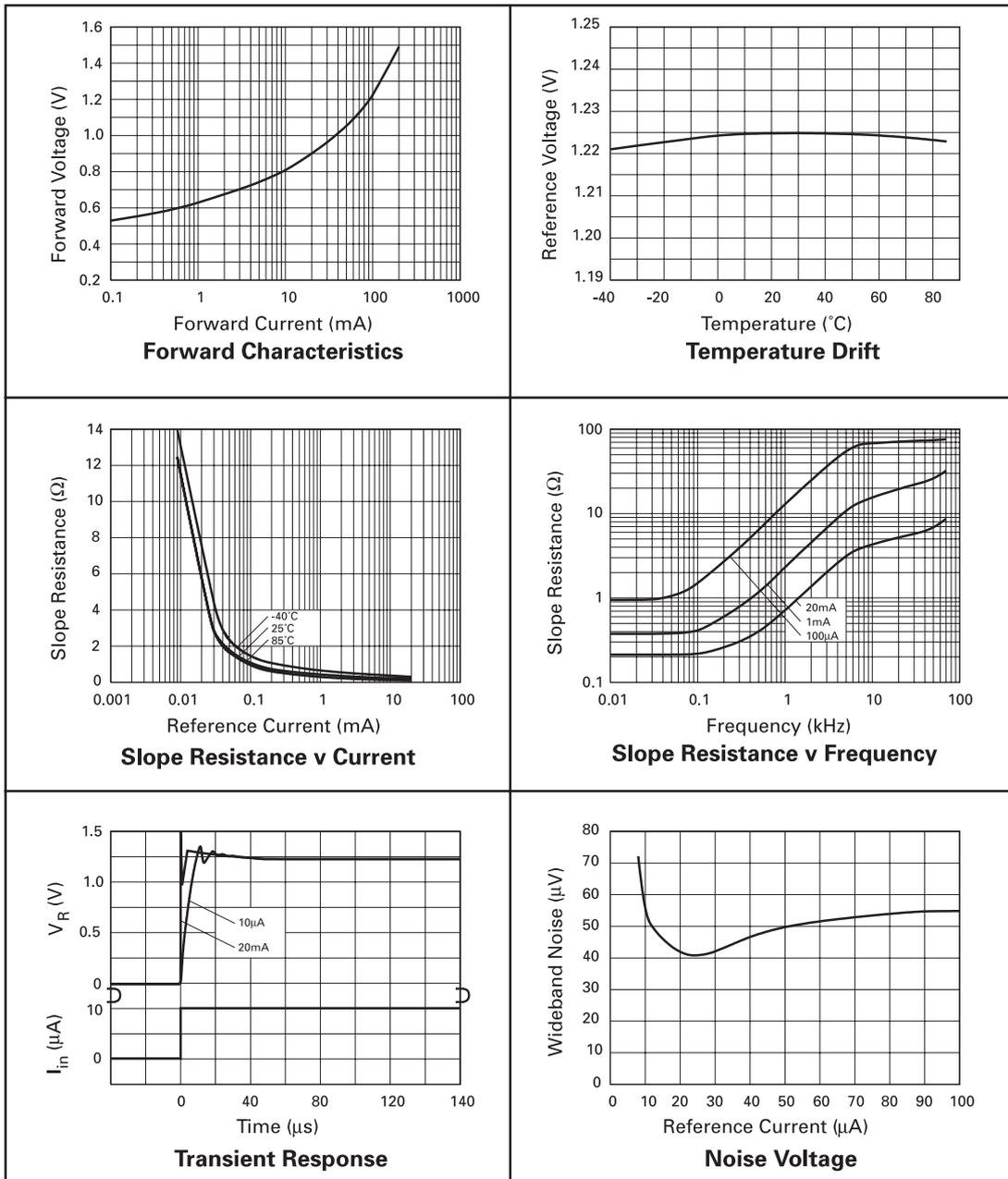

ZXRE125

SOT23 PACKAGE OUTLINE AND PAD LAYOUT DETAILS

PACKAGE OUTLINE

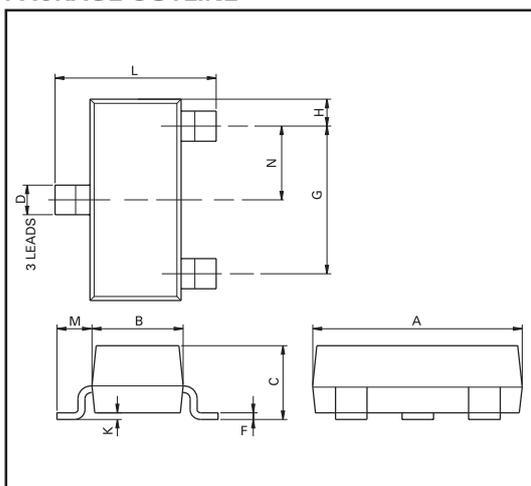

PAD LAYOUT

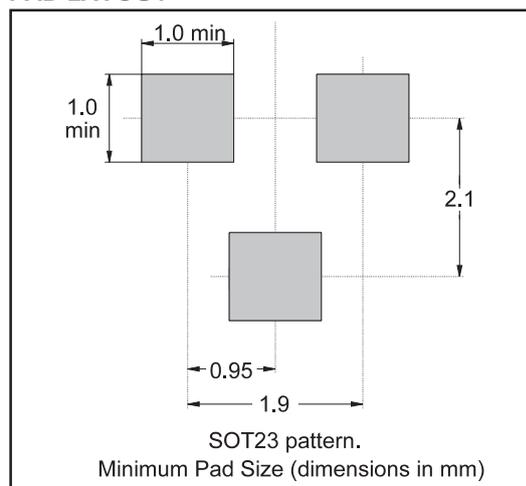

Controlling dimensions are in millimetres. Approximate conversions are given in inches

PACKAGE DIMENSIONS

DIM	Millimetres		Inches		DIM	Millimetres		Inches	
	Min	Max	Min	Max		Min	Max	Min	Max
A	2.67	3.05	0.105	0.120	G	NOM 1.9		NOM 0.037	
B	1.20	1.40	0.047	0.055	K	0.01	0.10	0.0004	0.004
C	-	1.10	-	0.043	L	2.10	2.50	0.083	0.0985
D	0.37	0.53	0.0145	0.021	N	NOM 0.95		NOM 0.037	
F	0.085	0.15	0.0033	0.0059					

ZXRE125

E-LINE PACKAGE OUTLINE

PACKAGE OUTLINE

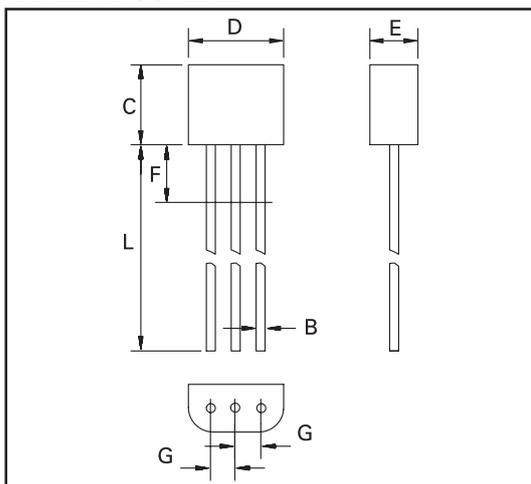

Controlling dimensions are in millimetres. Approximate conversions are given in inches

PACKAGE DIMENSIONS

DIM	Millimetres		Inches	
	Min	Max	Min	Max
A	0.41	0.495	0.016	0.0195
B	0.41	0.495	0.016	0.0195
C	3.61	4.01	0.142	0.158
D	4.37	4.77	0.172	0.188
E	2.16	2.41	0.085	0.095
F	—	2.50	—	0.098
G	1.27 NOM		0.050 NOM	
L	13.00	13.97	0.512	0.550

© Zetex plc 2003

Europe

Zetex plc
Fields New Road
Chadderton
Oldham, OL9 8NP
United Kingdom
Telephone (44) 161 622 4444
Fax: (44) 161 622 4446
hq@zetex.com

Zetex GmbH
Streitfeldstraße 19
D-81673 München
Germany
Telefon: (49) 89 45 49 49 0
Fax: (49) 89 45 49 49 49
europe.sales@zetex.com

Americas

Zetex Inc
700 Veterans Memorial Hwy
Hauppauge, NY 11788
USA
Telephone: (1) 631 360 2222
Fax: (1) 631 360 8222
usa.sales@zetex.com

Asia Pacific

Zetex (Asia) Ltd
3701-04 Metroplaza Tower 1
Hing Fong Road
Kwai Fong
Hong Kong
Telephone: (852) 26100 611
Fax: (852) 24250 494
asia.sales@zetex.com

These offices are supported by agents and distributors in major countries world-wide.

This publication is issued to provide outline information only which (unless agreed by the Company in writing) may not be used, applied or reproduced for any purpose or form part of any order or contract or be regarded as a representation relating to the products or services concerned. The Company reserves the right to alter without notice the specification, design, price or conditions of supply of any product or service.

For the latest product information, log on to www.zetex.com

ISSUE 7 - OCTOBER 2003